

FEATURES

- ▶ Ultra Compact Size 2.06x1.07x0.93 "
- ▶ Fully Encapsulated Plastic Case for PCB, Chassis and DIN-Rail Mounting Version
- ▶ Universal Input 85-264VAC, 90-370VDC, 47-440Hz
- ▶ I/O Isolation 3000VAC with Reinforced Insulation
- ▶ No Min. Load Requirement & Low no-load power consumption
- ▶ Operating Ambient Temp. Range -40°C to +70°C
- ▶ Overload/Voltage and Short Circuit Protection
- ▶ EMI Emission EN55014-1/55032 Class B Approved
- ▶ EMS Immunity EN61000-4-2,3,4,5,6,8,11 Approved
- ▶ Safety Approval to UL/cUL/IEC/EN 62368-1, IEC/EN 60335-1 & CE Marking

NEW

PRODUCT OVERVIEW

The MINMAX AMF-15 series is a new generation of fully encapsulated AC-DC power supply modules with ultra-compact size for higher power density and space saving.

The product features universal AC input 85-264VAC and wider DC input 90-370VDC, regulated output voltages 5.1, 12, 15, 24, 48VDC ; I/O Isolation 3000VAC with Reinforced Insulation ; EMI emission EN55014-1/32 Class B and EMS immunity EN 61000-4 standards approved ; no min. load requirement and low no-load power consumption ; abnormal protection mechanism with output overload, short circuit and overvoltage protections.

The AMF-15 series equips with PCB, Chassis and DIN-Rail Mounting Version for flexible installation and comply with UL/IEC/EN 62368-1 & IEC/EN 60335-1 for safety usage. It provides a cost effective solution especially for space critical applications in industrial and household electronic equipment.

Model Selection Guide

Model Number	Output Voltage	Output Power	Output Current	Input Current	Max. capacitive Load	Efficiency
				115VAC, 60Hz		(typ.)
				@Max. Load		@Max. Load, 115VAC
	VDC	W	mA	mA(typ.)	μF	%
AMF-15S051	5.1	15.3	3000	318	3300	80
AMF-15S12	12	15	1250	306	560	85
AMF-15S15	15	15	1000	306	330	86
AMF-15S24	24	15	625	299	220	86
AMF-15S48	48	15.02	313	306	47	86

Input Specifications

Parameter	Conditions / Model	Min.	Typ.	Max.	Unit
AC Input Voltage Range	All Models	85	---	264	VAC
AC Input Frequency Range		47	---	440	Hz
DC Input Voltage Range		90	---	370	VDC
No-Load Power Consumption	115VAC	---	---	150	mW
	230VAC	---	---	300	mW
Inrush Current (Cold Start at 25°C)	115VAC	---	---	25	A
	230VAC	---	---	45	A

Output Specifications						
Parameter	Conditions / Model	Min.	Typ.	Max.	Unit	
Output Voltage Setting Accuracy		---	±1.0	±2.0	%	
Line Regulation	Vin=Min. to Max. @Full Load	---	---	±0.5	%	
Load Regulation	Io=0% to 100%	---	---	±1.0	%	
Minimum Load	No minimum Load Requirement					
Ripple & Noise	0-20 MHz Bandwidth	5.1VDC Output Model	---	---	80	mV _{P-P}
		Other Output Models	---	---	1	%V _{PP} of V _O
Temperature Coefficient		---	±0.01	±0.02	%/°C	
Over Load Protection	auto-recovery (long term overload condition may cause damage)	---	150	---	%I _{nom.}	
Short Circuit Protection	Hiccup mode, Automatic Recovery					

General Specifications						
Parameter	Conditions	Min.	Typ.	Max.	Unit	
I/O Isolation Voltage	60 Seconds	3000	---	---	VAC	
I/O Isolation Resistance	500 VDC	10	---	---	GΩ	
Switching Frequency		---	---	125	kHz	
Hold-up Time	115VAC, 60Hz	8	---	---	ms	
	230VAC, 50Hz	40	---	---	ms	
MTBF (calculated)	MIL-HDBK-217F@25°C, Ground Benign	458,989	---	---	Hours	
Safety Approvals	UL/cUL 62368-1 recognition(UL certificate), IEC/EN 62368-1(CB-report) IEC/EN 60335-1, 61558-1, 61558-2-16 recognition(CB-report)					

EMC Specifications					
Parameter	Standards & Level			Performance	
General	Compliance with EN 61204-3 Switch mode power supplies				
EMI	Conduction	EN 55014-1, EN 55032		Without external components Class B	
	Radiation				
EMS	EN 55014-2, EN 55035				
	ESD	Direct discharge	Indirect discharge HCP & VCP		A
		EN 61000-4-2 Air ± 8kV		Contact ± 6kV	
	Radiated immunity	EN 61000-4-3 10V/m			A
	Fast transient	EN 61000-4-4 ±2kV			A
	Surge	EN 61000-4-5 ±1kV			A
	Conducted immunity	EN 61000-4-6 10Vrms			A
	PFMF	EN 61000-4-8 30A/m			A
Dips	EN 61000-4-11 30% 10ms			A	
Interruptions	EN 61000-4-11 >95% 5000ms			B	

Environmental Specifications				
Parameter	Min.	Max.	Unit	
Operating Ambient Temperature Range (See Power Derating Curve)	-40	+70	°C	
Storage Temperature Range	-40	+85	°C	
Humidity (non condensing)	---	95	% rel. H	
Lead Temperature (1.5mm from case for 10Sec.)	---	260	°C	

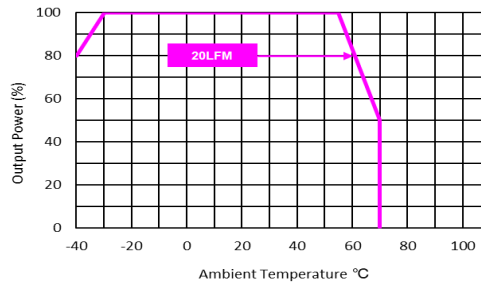
Power Derating Curve

Notes

- 1 All specifications typical at Ta=+25°C, resistive load, 115VAC, 60Hz input voltage and after warm-up time rated output current unless otherwise noted.
- 2 We recommend to protect the converter by a slow blow fuse in the input supply line.
- 3 Other input and output voltage may be available, please contact MINMAX.
- 4 The continuous operation on DC input voltage of 80VDC to 370VDC is available after start-up at 90VDC.
- 5 Specifications are subject to change without notice.

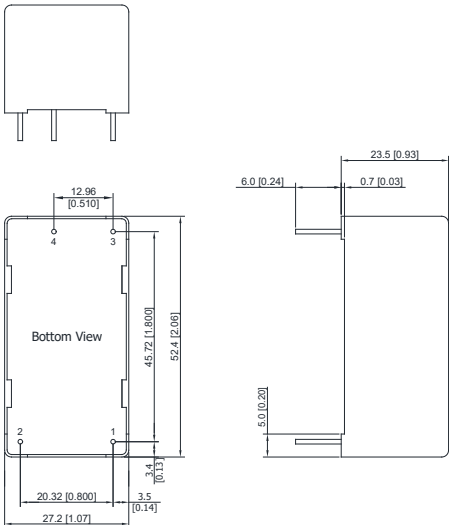
Package Specifications PCB Mounting

Mechanical Dimensions		Pin Connections		
		Pin	Function	Diameter mm (inches)
		1	AC(N)	∅ 1.0 [0.04]
		2	AC(L)	∅ 1.0 [0.04]
		3	+Vout	∅ 1.0 [0.04]
		4	-Vout	∅ 1.0 [0.04]

▶ All dimensions in mm (inches)
 ▶ Tolerance: ±0.5 (±0.02)
 ▶ Pin pitch tolerance: ±0.25 (±0.01)
 ▶ Pin diameter tolerance: X.X±0.1 (X.XX±0.004)

Physical Characteristics

Case Size	: 52.4x27.2x23.5mm (2.06x1.07x0.93 inches)
Case Material	: Plastic resin (flammability to UL 94V-0 rated)
Pin Material	: Copper Alloy
Weight	: 51g

Package Specifications Chassis Mounting with screw terminal (order code suffix C)

Mechanical Dimensions

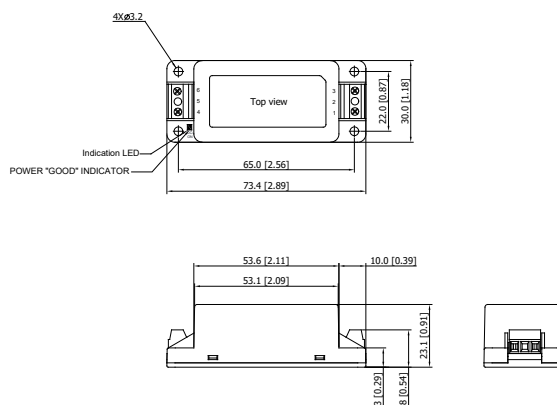

Note:
Screw type Terminal: Wires 1.5mm² max.
Recommended Terminal Screw tightening torque: 0.2Nm (1.7lb.in.) max.

Pin Connections

Pin	Function
1	AC(N)
2	No Pin
3	AC(L)
4	+Vout
5	No Pin
6	-Vout

- ▶ All dimensions in mm (inches)
- ▶ Tolerance: ±0.5 (±0.02)

Physical Characteristics

Case Size	: 73.4x30.0x23.1mm (2.89x1.18x0.91 inches)
Case Material	: Plastic resin (flammability to UL 94V-0 rated)
Weight	: 56g

Package Specifications for screw terminal with DIN Rail Mounting (order code suffix AC-DIN-06)

Mechanical Dimensions

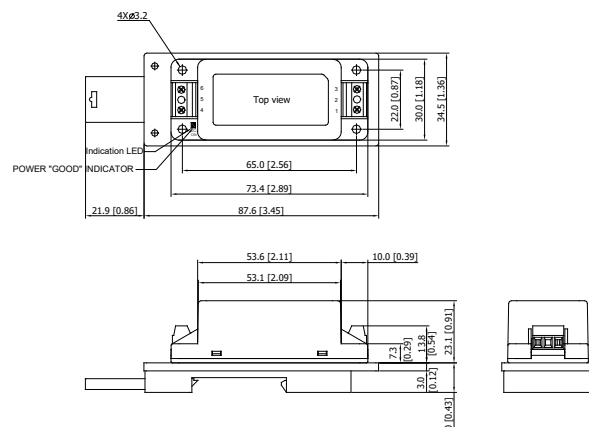

Physical Characteristics

Case Size	: 73.4x30.0x23.1mm (2.89x1.18x0.91 inches)
Case Material	: Plastic resin (flammability to UL 94V-0 rated)
Weight	: 101g

Screw terminal with DIN Rail Mounting

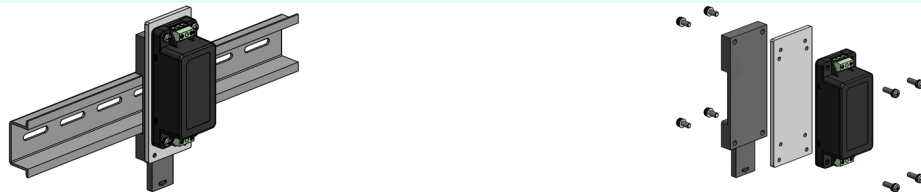

Package Specifications Chassis Mounting with JST connection (order code suffix CD)

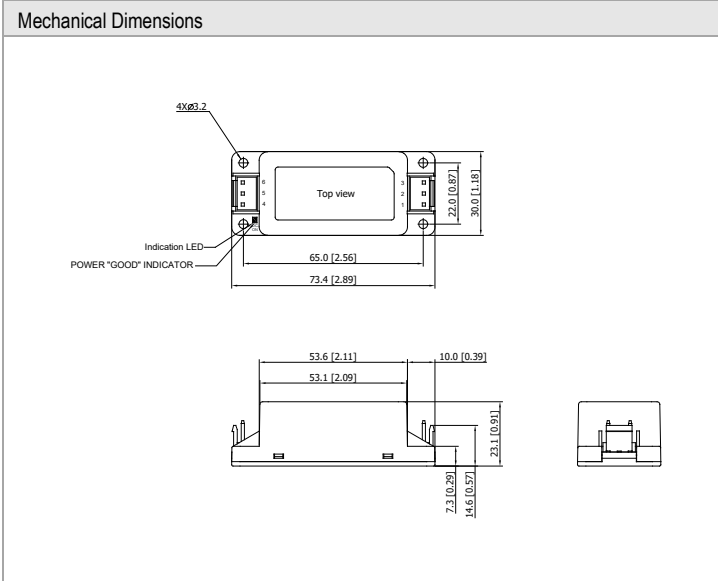

Pin Connections

Pin	Function
1	AC(N)
2	No Pin
3	AC(L)
4	No Pin
5	+Vout
6	-Vout

Input (pin 1, pin 3): JST Connector
mates with JST crimp contacts: SVH-41T-P1.1
terminal housing: VAR-2
Output (pin 5, pin 6): JST Connector
mates with JST crimp contacts: SVH-41T-P1.1
terminal housing: VHR-3

- ▶ All dimensions in mm (inches)
- ▶ Tolerance: ± 0.5 (± 0.02)

Physical Characteristics

Case Size	: 73.4x30.0x23.1mm (2.89x1.18x0.91 inches)
Case Material	: Plastic resin (flammability to UL 94V-0 rated)
Weight	: 56g

Package Specifications for JST connection with DIN Rail Mounting (order code suffix AC-DIN-06)

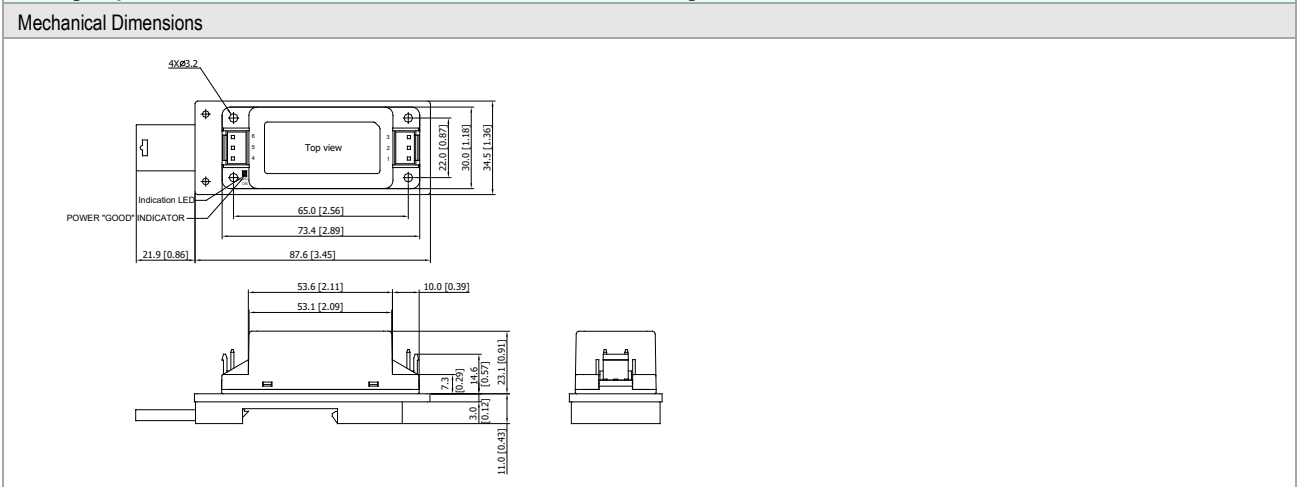

Physical Characteristics

Case Size	: 73.4x30.0x23.1mm (2.89x1.18x0.91 inches)
Case Material	: Plastic resin (flammability to UL 94V-0 rated)
Weight	: 101g

JST connection with DIN Rail Mounting

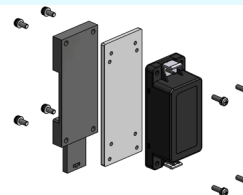
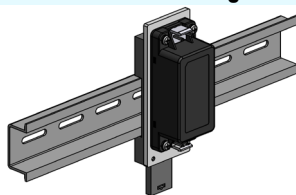

Order Code Table					
PCB Mounting	Chassis Mounting with screw terminal		Chassis Mounting with JST connection		DIN Rail Kit
	Power module only	Power module with Din Rail Kit	Power module only	Power module with Din Rail Kit	
AMF-15S051	AMF-15S051C	AMF-15S051C-AC-DIN-06	AMF-15S051CD	AMF-15S051CD-AC-DIN-06	AC-DIN-06
AMF-15S12	AMF-15S12C	AMF-15S12C-AC-DIN-06	AMF-15S12CD	AMF-15S12CD-AC-DIN-06	AC-DIN-06
AMF-15S15	AMF-15S15C	AMF-15S15C-AC-DIN-06	AMF-15S15CD	AMF-15S15CD-AC-DIN-06	AC-DIN-06
AMF-15S24	AMF-15S24C	AMF-15S24C-AC-DIN-06	AMF-15S24CD	AMF-15S24CD-AC-DIN-06	AC-DIN-06
AMF-15S48	AMF-15S48C	AMF-15S48C-AC-DIN-06	AMF-15S48CD	AMF-15S48CD-AC-DIN-06	AC-DIN-06