



MKW20M Series

DC-DC CONVERTER 20W, Reinforced Insulation, Medical Safety

Electric Characteristic Note

Features

- ▶ Industrial Standard 2" X 1" Package
- ▶ Wide 2:1 Input Voltage Range
- ▶ Fully Regulated Output Voltage
- ▶ I/O Isolation 4200VAC with Reinforced Insulation, rated for 300Vrms Working Voltage
- ▶ Low I/O Leakage Current < 5μA
- ▶ Operating Ambient Temp. Range -40°C to +80°C
- ▶ No Min. Load Requirement
- ▶ Under-voltage, Overload/Voltage and Short Circuit Protection
- ▶ EMI Emission EN 55011 Class A Approved
- ▶ Medical EMC Standard with 4th Edition of EMI EN 55011 and EMS EN 60601-1-2 Approved
- ▶ Medical Safety with 2xMOPP per 3rd Edition of IEC/EN 60601-1 & ANSI/AAMI ES60601-1 Approved with CE Marking



Applications

- ▶ Distributed power architectures
- ▶ Workstations
- ▶ Computer equipment
- ▶ Communications equipment

General Description

The MINMAX MKW20M series is a range of high performance 20W medical approved DC-DC converter within encapsulated 2"x1" package which specifically design for medical applications. There are 21 models available for input voltage of 12, 24, 48VDC with wide 2:1 input range and fixed output voltage. The I/O isolation is specified for 4200VAC with reinforced insulation, which rated for 300Vrms working voltage. Further features include under-voltage, overload, over voltage, short circuit protection, no min. load requirement, EMI emission EN 55011 class A approved, low I/O leakage current 5μA max. and operating ambient temp. range by -40°C to 80°C by high efficiency up to 90%. MKW20M series conform to 4th edition medical EMC standard, medical safety with 2xMOPP (Means Of Patient Protection) per 3rd edition of IEC/EN 60601-1 & ANSI/AAMI ES60601-1 approved. The MKW20M series offer a perfect solution for demanding applications in medical instrument requesting a certified supplementary and reinforced insulation system to comply with latest medical safety approval for 2xMOPP requirement.

Table of contents

Model Selection Guide.....	P2	Package Specifications.....	P26
Input Specifications.....	P2	Recommended Pad Layout for Single & Dual Output Converter.....	P26
Output Specifications.....	P3	Test Setup.....	P27
Isolation, Safety Standards.....	P3	Technical Notes.....	P28
General Specifications.....	P3	Packaging Information.....	P28
EMC Specifications.....	P3	Wave Soldering Considerations.....	P28
Environmental Specifications.....	P4	Part Number Structure.....	P29
Characteristic Curves.....	P5	MTBF and Reliability.....	P29

Model Selection Guide										
Model Number	Input Voltage (Range)	Output Voltage	Output Current	Input Current		Reflected Ripple Current	Over Voltage Protection	Max. capacitive Load	Efficiency (typ.)	
			Max.	@Max. Load	@No Load				@Max. Load	
	VDC	VDC	mA	mA(typ.)	mA (typ.)	mA(typ.)	VDC	μF	%	
MKW20-12S05M	12 (9 ~ 18)	5	4000	1938	20	100	6.2	6800	86	
MKW20-12S051M		5.1	4000	1977			6.2		86	
MKW20-12S12M		12	1670	1876			15		1160	89
MKW20-12S15M		15	1333	1893			18		750	88
MKW20-12S24M		24	840	1888			27		295	89
MKW20-12D12M		±12	±840	1888			±15		590#	89
MKW20-12D15M		±15	±670	1882			±18		380#	89
MKW20-24S05M	24 (18 ~ 36)	5	4000	947	15	50	6.2	6800	88	
MKW20-24S051M		5.1	4000	966			6.2		88	
MKW20-24S12M		12	1670	938			15		1160	89
MKW20-24S15M		15	1333	936			18		750	89
MKW20-24S24M		24	840	933			27		295	90
MKW20-24D12M		±12	±840	933			±15		590#	90
MKW20-24D15M		±15	±670	931			±18		380#	90
MKW20-48S05M	48 (36 ~ 75)	5	4000	473	10	30	6.2	6800	88	
MKW20-48S051M		5.1	4000	483			6.2		88	
MKW20-48S12M		12	1670	469			15		1160	89
MKW20-48S15M		15	1333	463			18		750	90
MKW20-48S24M		24	840	472			27		295	89
MKW20-48D12M		±12	±840	472			±15		590#	89
MKW20-48D15M		±15	±670	465			±18		380#	90

For each output

Input Specifications						
Parameter	Conditions/Model	Min.	Typ.	Max.	Unit	
Input Surge Voltage (100 ms max.)	12V Input Models	-0.7	---	25	VDC	
	24V Input Models	-0.7	---	50		
	48V Input Models	-0.7	---	100		
Start-Up Threshold Voltage	12V Input Models	---	---	9		
	24V Input Models	---	---	18		
	48V Input Models	---	---	36		
Under Voltage Shutdown	12V Input Models	---	7.5	---		
	24V Input Models	---	15	---		
	48V Input Models	---	33	---		
Start Up Time (Power On)	Nominal Vin and Constant Resistive Load	---	---	30	ms	
Input Filter	All Models	Internal Pi Type				

Output Specifications							
Parameter	Conditions/Model		Min.	Typ.	Max.	Unit	
Output Voltage Setting Accuracy			---	---	±1.0	%Vnom.	
Output Voltage Balance	Dual Output, Balanced Loads		---	---	±2.0	%	
Line Regulation	Vin=Min. to Max. @Full Load		---	---	±0.5	%	
Load Regulation	Io=0% to 100%	Single Output	---	---	±0.5	%	
		Dual Output	---	---	±1.0	%	
Minimum Load	No minimum Load Requirement						
Ripple & Noise	0-20 MHz Bandwidth	5V & 5.1Vo	Measured with a MLCC : 4.7µF	---	50	---	mV _{P-P}
		12V,15V, ±12V, ±15Vo		---	100	---	mV _{P-P}
		24Vo		---	150	---	mV _{P-P}
Transient Recovery Time	25% Load Step Change ₍₂₎		---	---	300	µsec	
Transient Response Deviation			---	±3	±5	%	
Temperature Coefficient			---	---	±0.02	%/°C	
Over Load Protection	Hiccup		---	150	---	%	
Short Circuit Protection	Continuous, Automatic Recovery (Hiccup Mode 0.7Hz typ.)						

Isolation, Safety Standards						
Parameter	Conditions		Min.	Typ.	Max.	Unit
I/O Isolation Voltage	60 Seconds Reinforced insulation, rated for 300Vrms working voltage		4200	---	---	VAC
Leakage Current	240VAC, 60Hz		---	---	5	µA
I/O Isolation Resistance	500 VDC		10	---	---	GΩ
I/O Isolation Capacitance	100kHz, 1V		---	---	80	pF
Safety Standards	ANSI/AAMI ES 60601-1, CAN/CSA-C22.2 No. 60601-1					
	IEC/EN 60601-1 3 rd Edition 2xMOPP					
Safety Approvals	ANSI/AAMI ES 60601-1 2xMOPP recognition (UL certificate), IEC/EN 60601-1 3 rd Edition (CB-report)					

General Specifications						
Parameter	Conditions		Min.	Typ.	Max.	Unit
Switching Frequency			---	285	---	kHz
MTBF(calculated)	MIL-HDBK-217F@25°C, Ground Benign		1,087,344	---	---	Hours

EMC Specifications				
Parameter	Standards & Level			Performance
	EMI	Conduction	EN 55011	Without external components
Radiation				
EMS	EN 60601-1-2 4 th			
	ESD	EN 61000-4-2 Air ± 15kV, Contact ± 8kV		A
	Radiated immunity	EN 61000-4-3 10V/m		A
	Fast transient (s)	EN 61000-4-4 ±2kV		A
	Surge (s)	EN 61000-4-5 ±1kV		A
	Conducted immunity	EN 61000-4-6 10Vrms		A
	PFMF	EN 61000-4-8 100A/M		A

Environmental Specifications				
Parameter	Conditions/Model	Min.	Max.	Unit
Operating Ambient Temperature Range Nominal Vin, Load 100% Inom. (for Power Derating see relative Derating Curves)	MKW20-24S24M, MKW20-24D12M, MKW20-24D15M MKW20-48S15M, MKW20-48D15M	-40	66	°C
	MKW20-12S12M, MKW20-12S24M, MKW20-12D12M MKW20-12D15M, MKW20-24S12M, MKW20-24S15M MKW20-48S12M, MKW20-48S24M, MKW20-48D12M		62	
	MKW20-12S15M, MKW20-24S05M, MKW20-24S051M MKW20-48S05M, MKW20-48S051M		58	
	MKW20-12S05M, MKW20-12S051M		51	
Thermal Impedance		13.0	---	°C/W
Case Temperature		---	+95	°C
Storage Temperature Range		-50	+125	°C
Humidity (non condensing)		---	95	% rel. H
Altitude		---	4000	M
Lead Temperature (1.5mm from case for 10Sec.)		---	260	°C

Notes
<ol style="list-style-type: none"> 1 Specifications typical at Ta=+25°C, resistive load, nominal input voltage and rated output current unless otherwise noted. 2 Transient recovery time is measured to within 1% error band for a step change in output load of 75% to 100%. 3 We recommend to protect the converter by a slow blow fuse in the input supply line. 4 Other input and output voltage may be available, please contact MINMAX. 5 To meet EN 61000-4-4 & EN 61000-4-5 an external capacitor across the input pins is required, please contact MINMAX. 6 Specifications are subject to change without notice.

Characteristic Curves

All test conditions are at 25°C The figures are identical for MKW20-12S05M

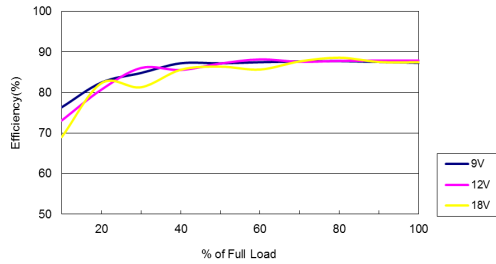

Efficiency Versus Output Current

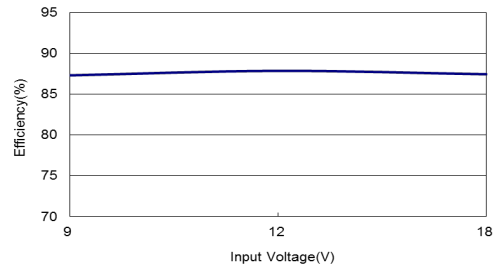

Efficiency Versus Input Voltage Full Load

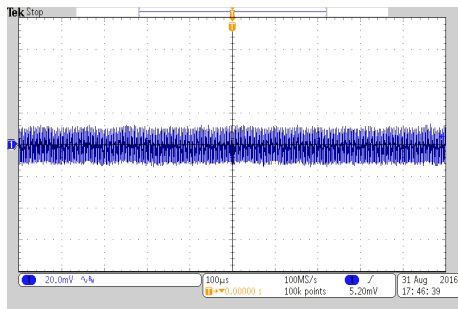

Typical Output Ripple and Noise
 $V_{in}=V_{in\ nom}$; Full Load

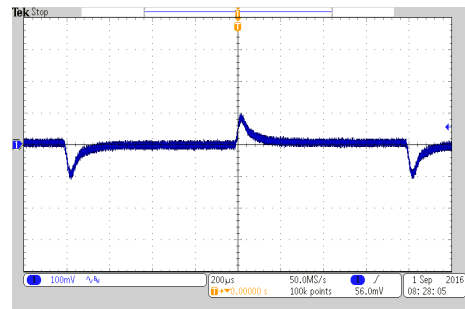

Transient Response to Dynamic Load Change
from 100% to 75% of Full Load ; $V_{in}=V_{in\ nom}$

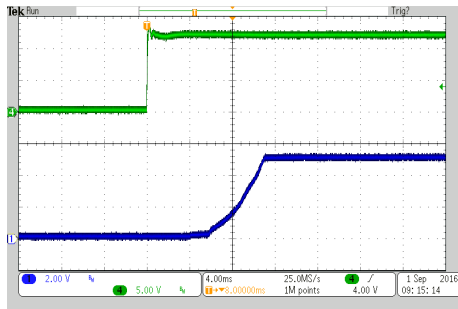

Typical Input Start-up and Output Rise Characteristic
 $V_{in}=V_{in\ nom}$; Full Load

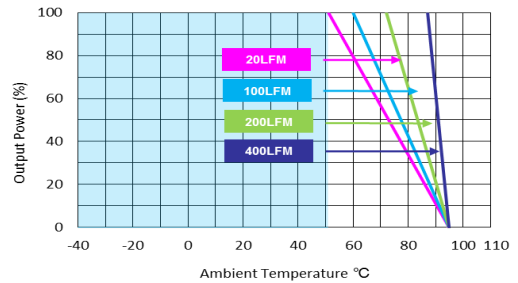

Derating Output Power Versus Ambient Temperature and Airflow
 $V_{in}=V_{in\ nom}$

Characteristic Curves

All test conditions are at 25°C. The figures are identical for MKW20-12S051M

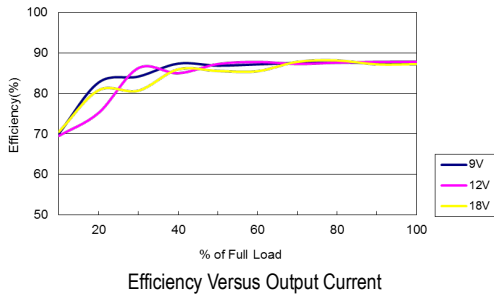

Efficiency Versus Output Current

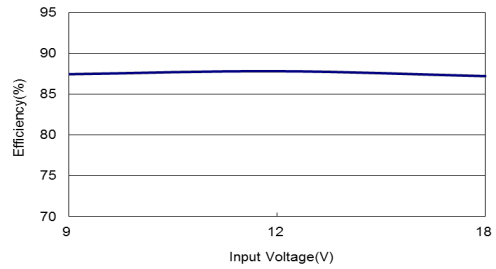

Efficiency Versus Input Voltage Full Load

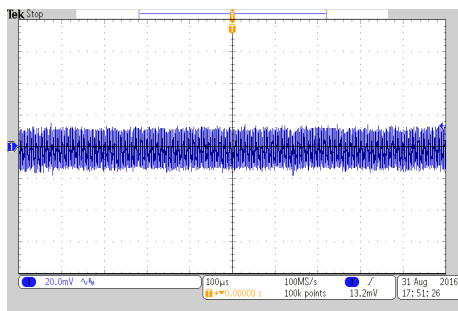

Typical Output Ripple and Noise
 $V_{in}=V_{in\ nom}$; Full Load

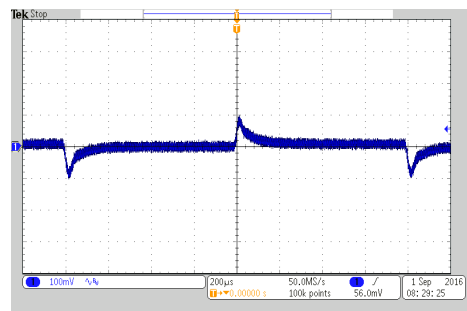

Transient Response to Dynamic Load Change
from 100% to 75% of Full Load ; $V_{in}=V_{in\ nom}$

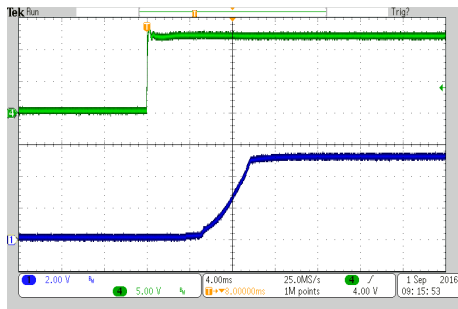

Typical Input Start-Up and Output Rise Characteristic
 $V_{in}=V_{in\ nom}$; Full Load

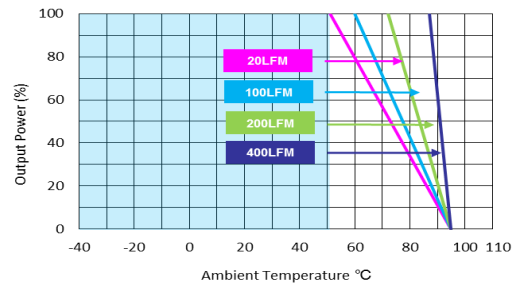

Derating Output Power Versus Ambient Temperature and Airflow
 $V_{in}=V_{in\ nom}$

Characteristic Curves

All test conditions are at 25°C The figures are identical for MKW20-12S12M

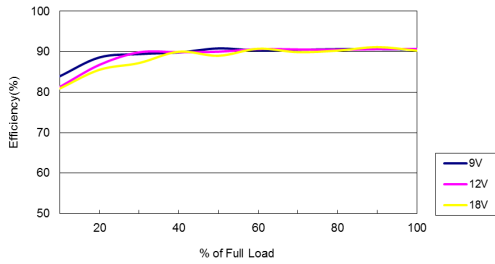

Efficiency Versus Output Current

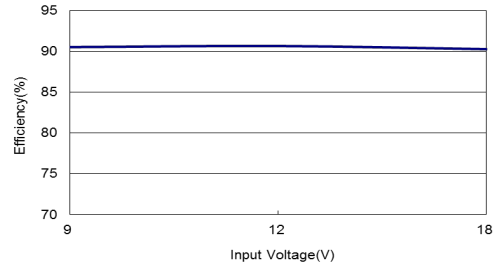

Efficiency Versus Input Voltage Full Load

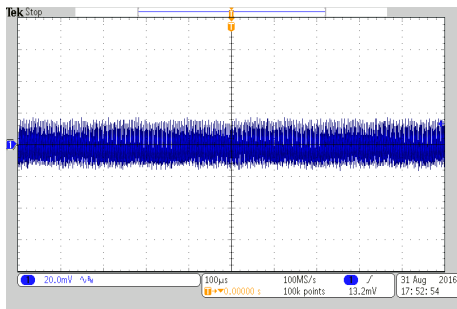

Typical Output Ripple and Noise
 $V_{in}=V_{in\ nom}$; Full Load

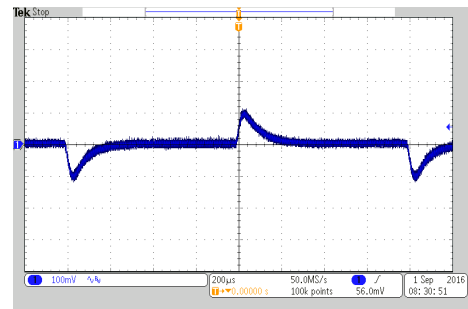

Transient Response to Dynamic Load Change
from 100% to 75% of Full Load ; $V_{in}=V_{in\ nom}$

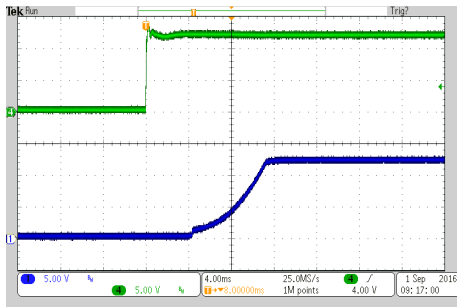

Typical Input Start-Up and Output Rise Characteristic
 $V_{in}=V_{in\ nom}$; Full Load

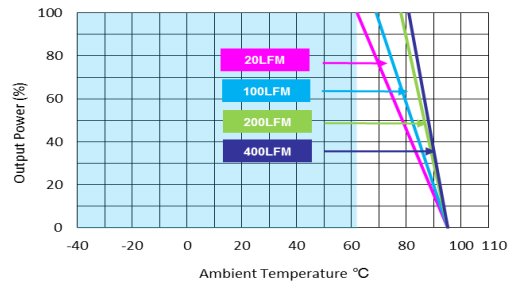

Derating Output Power Versus Ambient Temperature and Airflow
 $V_{in}=V_{in\ nom}$

Characteristic Curves

All test conditions are at 25°C The figures are identical for MKW20-12S15M

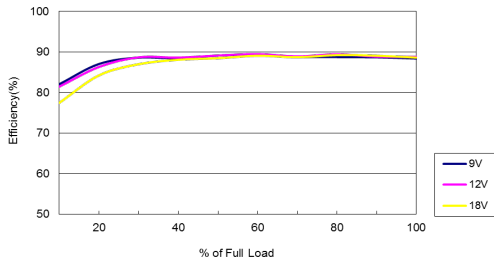

Efficiency Versus Output Current

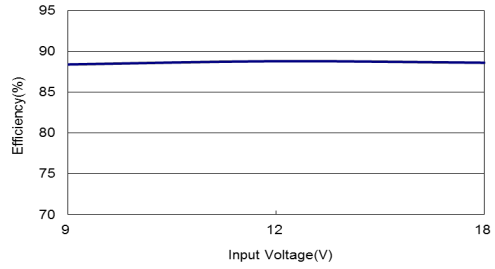

Efficiency Versus Input Voltage Full Load

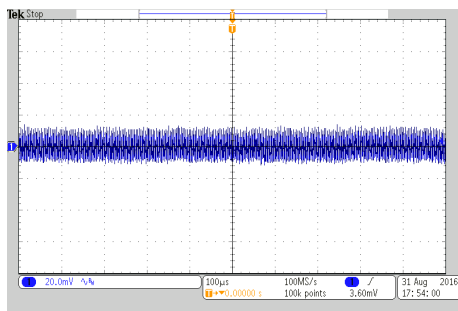

Typical Output Ripple and Noise
 $V_{in}=V_{in\ nom}$; Full Load

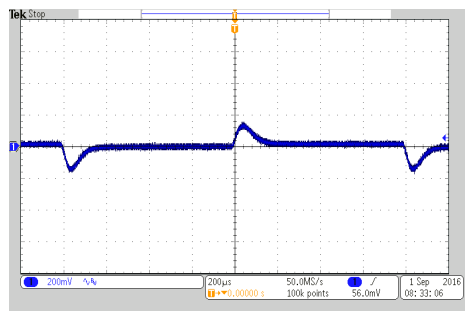

Transient Response to Dynamic Load Change
from 100% to 75% of Full Load ; $V_{in}=V_{in\ nom}$

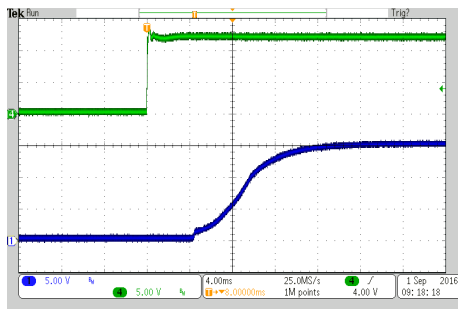

Typical Input Start-Up and Output Rise Characteristic
 $V_{in}=V_{in\ nom}$; Full Load

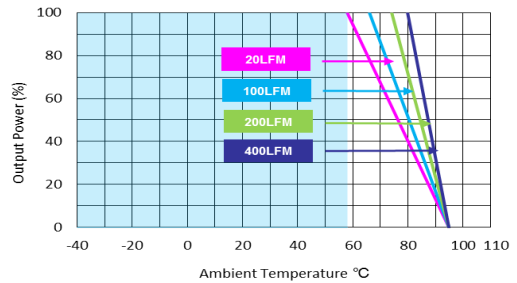

Derating Output Power Versus Ambient Temperature and Airflow
 $V_{in}=V_{in\ nom}$

Characteristic Curves

All test conditions are at 25°C The figures are identical for MKW20-12S24M

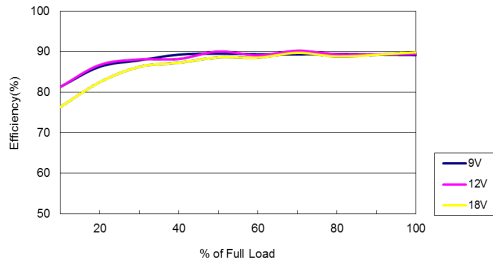

Efficiency Versus Output Current

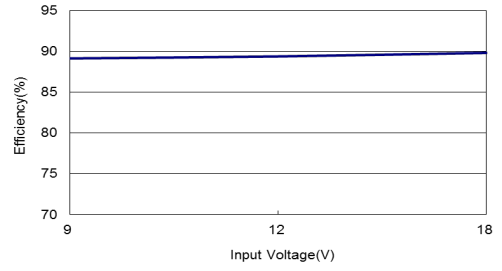

Efficiency Versus Input Voltage Full Load

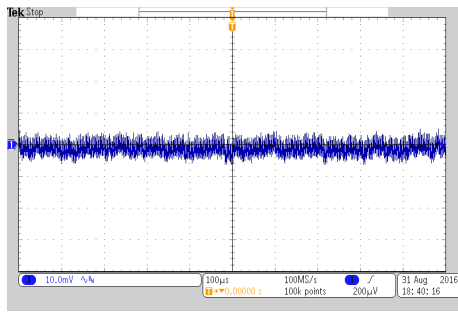

Typical Output Ripple and Noise
 $V_{in}=V_{in\ nom}$; Full Load

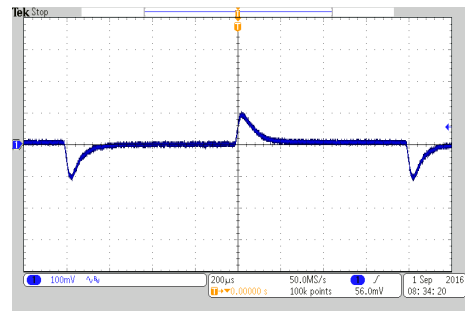

Transient Response to Dynamic Load Change
from 100% to 75% of Full Load ; $V_{in}=V_{in\ nom}$

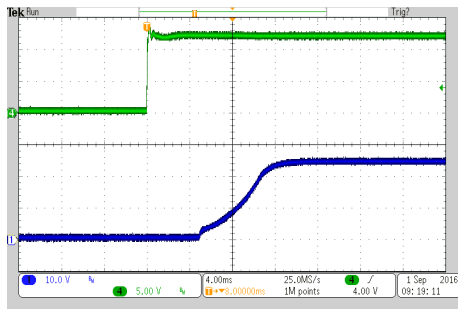

Typical Input Start-up and Output Rise Characteristic
 $V_{in}=V_{in\ nom}$; Full Load

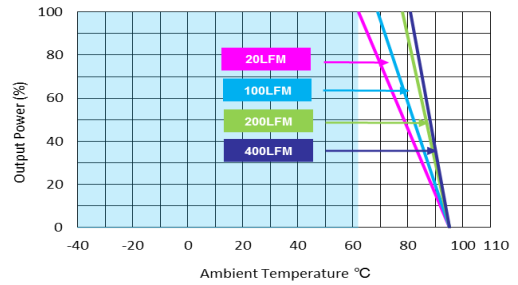

Derating Output Power Versus Ambient Temperature and Airflow
 $V_{in}=V_{in\ nom}$

Characteristic Curves

All test conditions are at 25°C The figures are identical for MKW20-12D12M

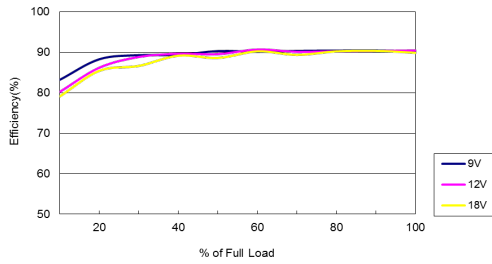

Efficiency Versus Output Current

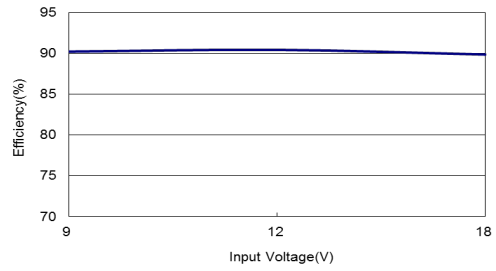

Efficiency Versus Input Voltage Full Load

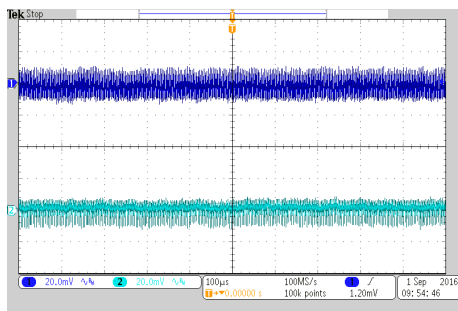

Typical Output Ripple and Noise
 $V_{in}=V_{in\ nom}$; Full Load

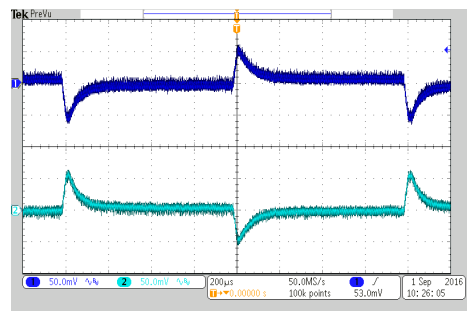

Transient Response to Dynamic Load Change from 100% to 75% of Full Load ; $V_{in}=V_{in\ nom}$

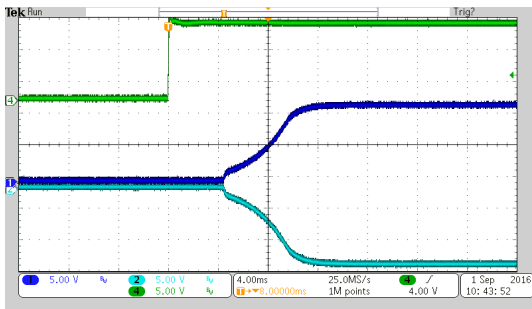

Typical Input Start-Up and Output Rise Characteristic
 $V_{in}=V_{in\ nom}$; Full Load

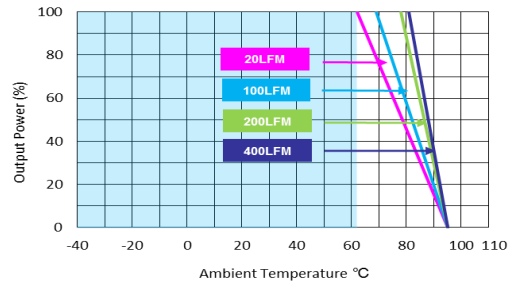

Derating Output Power Versus Ambient Temperature and Airflow
 $V_{in}=V_{in\ nom}$

Characteristic Curves

All test conditions are at 25°C The figures are identical for MKW20-12D15M

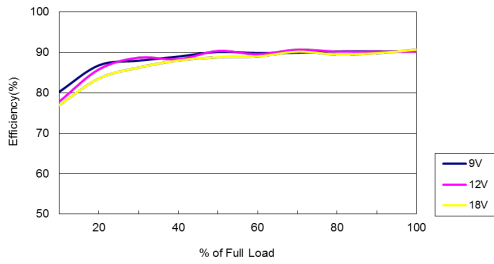

Efficiency Versus Output Current

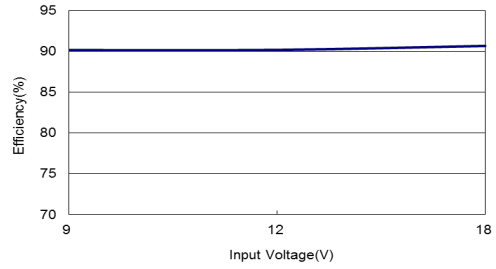

Efficiency Versus Input Voltage Full Load

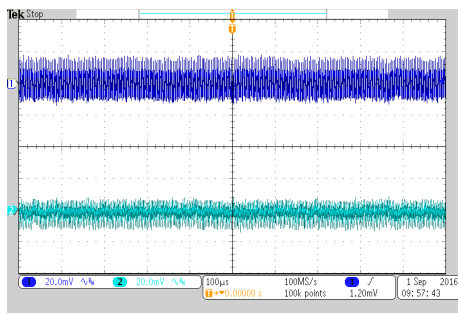

Typical Output Ripple and Noise
 $V_{in}=V_{in\ nom}$; Full Load

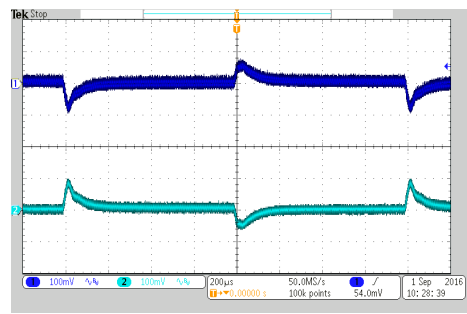

Transient Response to Dynamic Load Change from 100% to 75% of Full Load ; $V_{in}=V_{in\ nom}$

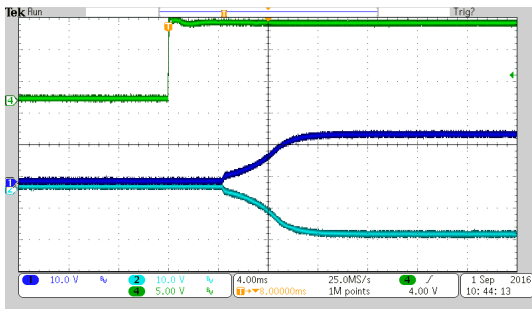

Typical Input Start-Up and Output Rise Characteristic
 $V_{in}=V_{in\ nom}$; Full Load

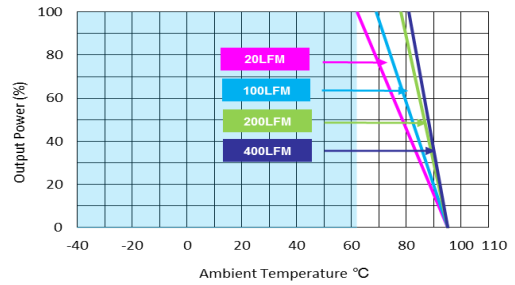

Derating Output Power Versus Ambient Temperature and Airflow
 $V_{in}=V_{in\ nom}$

Characteristic Curves

All test conditions are at 25°C. The figures are identical for MKW20-24S05M

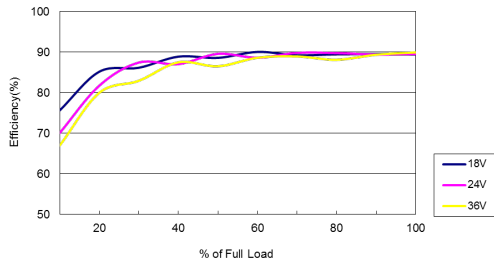

Efficiency Versus Output Current

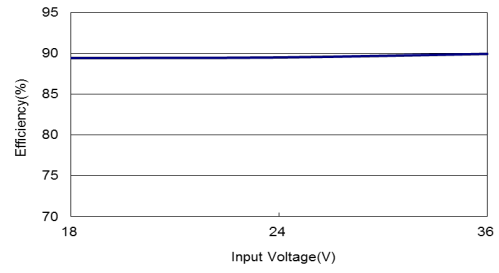

Efficiency Versus Input Voltage Full Load

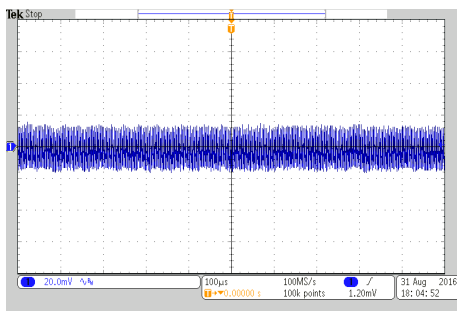

Typical Output Ripple and Noise
 $V_{in}=V_{in\ nom}$; Full Load

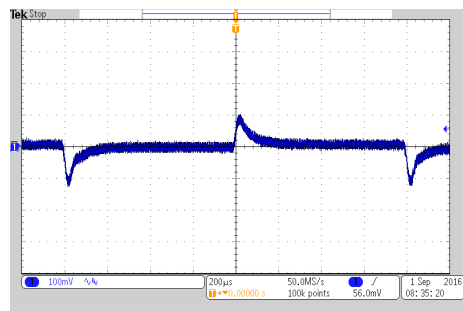

Transient Response to Dynamic Load Change
from 100% to 75% of Full Load; $V_{in}=V_{in\ nom}$

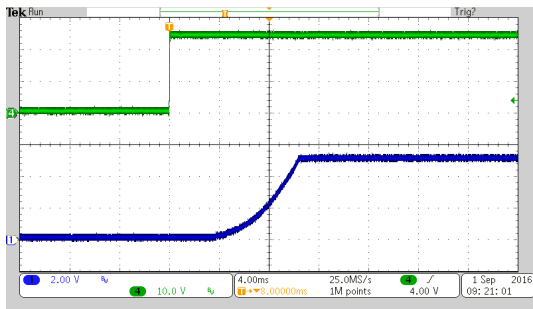

Typical Input Start-Up and Output Rise Characteristic
 $V_{in}=V_{in\ nom}$; Full Load

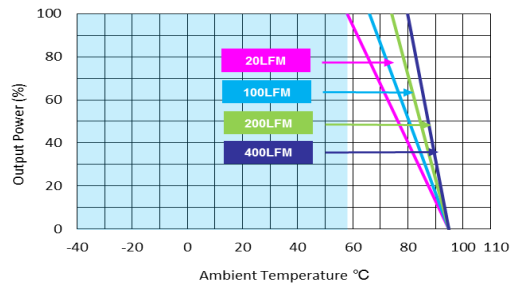

Derating Output Power Versus Ambient Temperature and Airflow
 $V_{in}=V_{in\ nom}$

Characteristic Curves

All test conditions are at 25°C The figures are identical for MKW20-24S051M

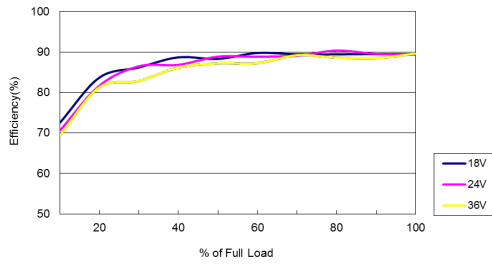

Efficiency Versus Output Current

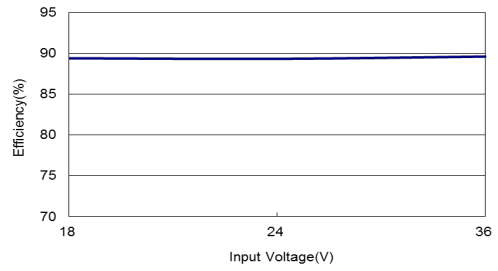

Efficiency Versus Input Voltage Full Load

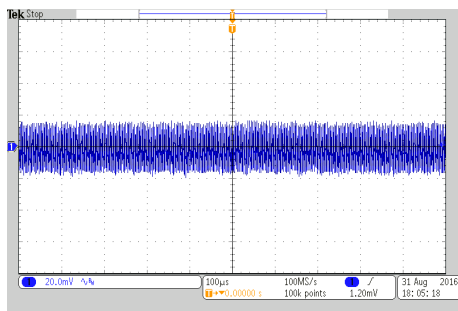

Typical Output Ripple and Noise
 $V_{in}=V_{in\ nom}$; Full Load

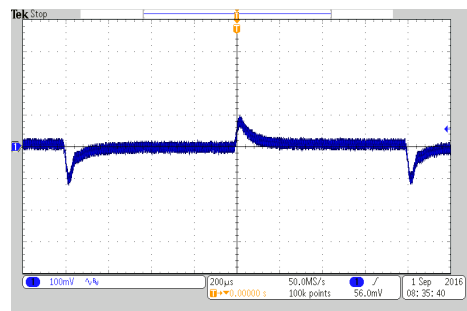

Transient Response to Dynamic Load Change
from 100% to 75% of Full Load ; $V_{in}=V_{in\ nom}$

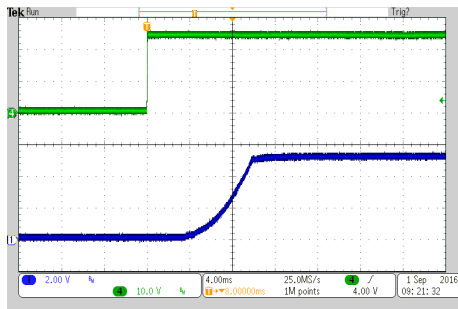

Typical Input Start-Up and Output Rise Characteristic
 $V_{in}=V_{in\ nom}$; Full Load

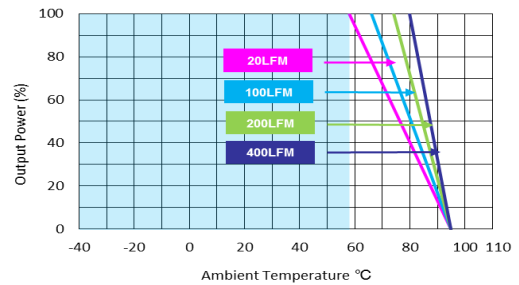

Derating Output Power Versus Ambient Temperature and Airflow
 $V_{in}=V_{in\ nom}$

Characteristic Curves

All test conditions are at 25°C. The figures are identical for MKW20-24S12M

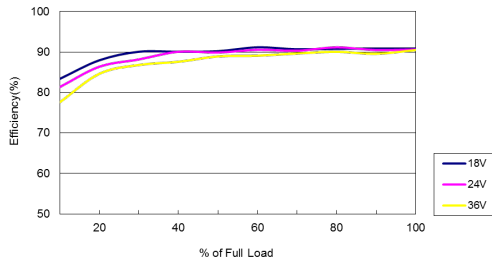

Efficiency Versus Output Current

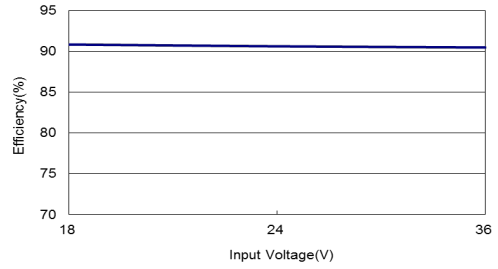

Efficiency Versus Input Voltage Full Load

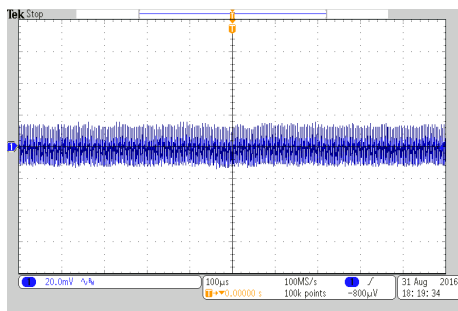

Typical Output Ripple and Noise
 $V_{in}=V_{in\ nom}$; Full Load

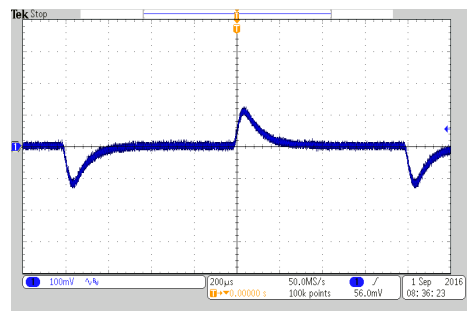

Transient Response to Dynamic Load Change
from 100% to 75% of Full Load ; $V_{in}=V_{in\ nom}$

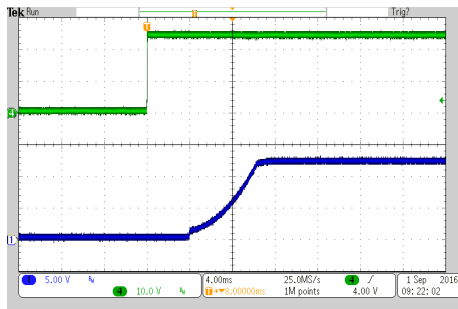

Typical Input Start-Up and Output Rise Characteristic
 $V_{in}=V_{in\ nom}$; Full Load

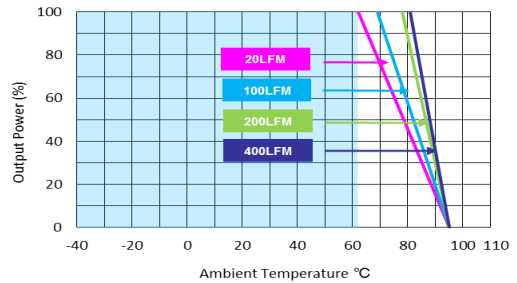

Derating Output Power Versus Ambient Temperature and Airflow
 $V_{in}=V_{in\ nom}$

Characteristic Curves

All test conditions are at 25°C. The figures are identical for MKW20-24S15M

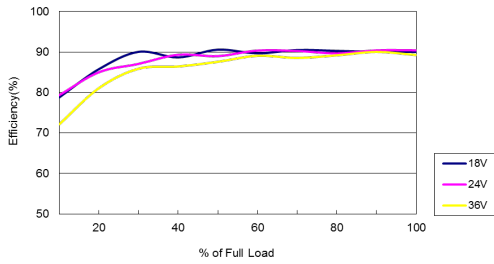

Efficiency Versus Output Current

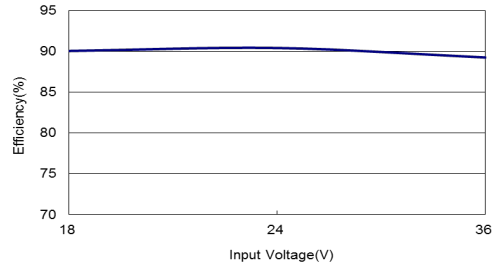

Efficiency Versus Input Voltage Full Load

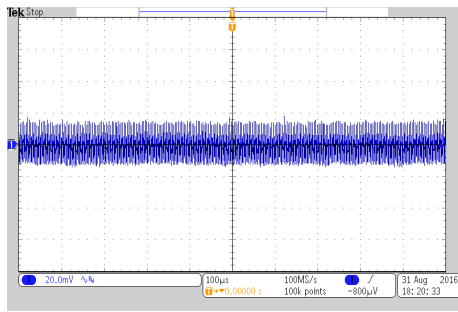

Typical Output Ripple and Noise
 $V_{in}=V_{in\ nom}$; Full Load

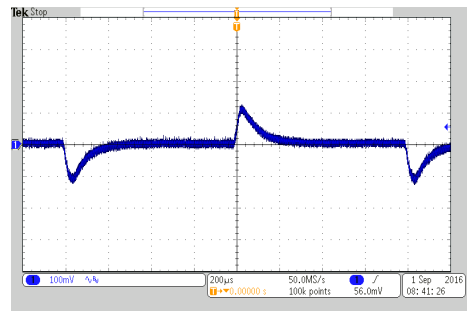

Transient Response to Dynamic Load Change
from 100% to 75% of Full Load ; $V_{in}=V_{in\ nom}$

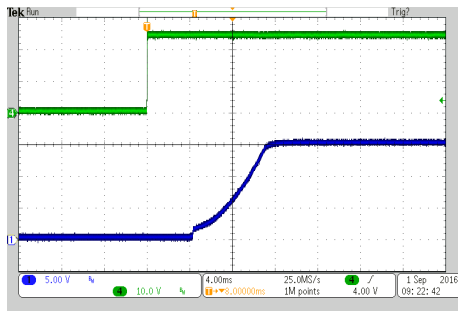

Typical Input Start-Up and Output Rise Characteristic
 $V_{in}=V_{in\ nom}$; Full Load

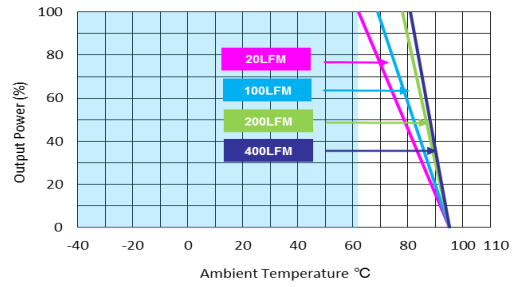

Derating Output Power Versus Ambient Temperature and Airflow
 $V_{in}=V_{in\ nom}$

Characteristic Curves

All test conditions are at 25°C The figures are identical for MKW20-24S24M

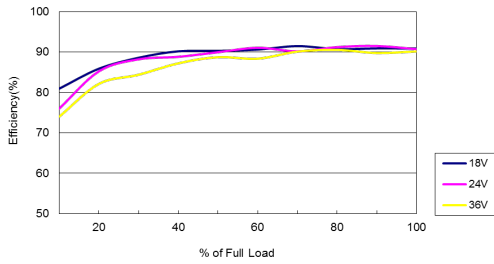

Efficiency Versus Output Current

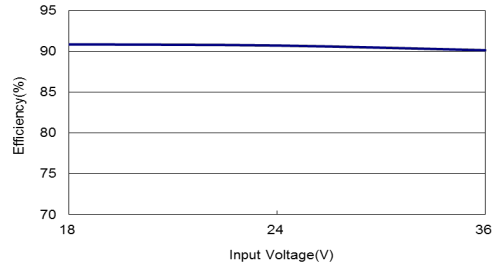

Efficiency Versus Input Voltage Full Load

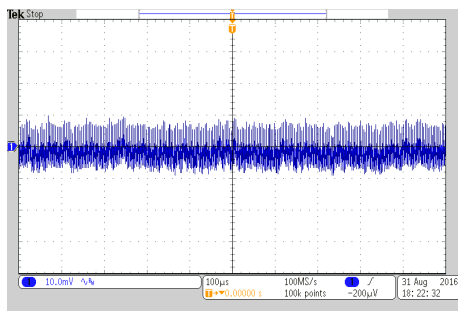

Typical Output Ripple and Noise
 $V_{in}=V_{in\ nom}$; Full Load

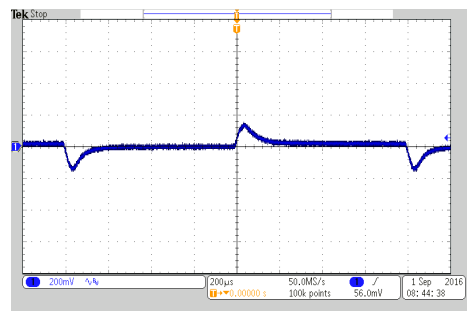

Transient Response to Dynamic Load Change
from 100% to 75% of Full Load ; $V_{in}=V_{in\ nom}$

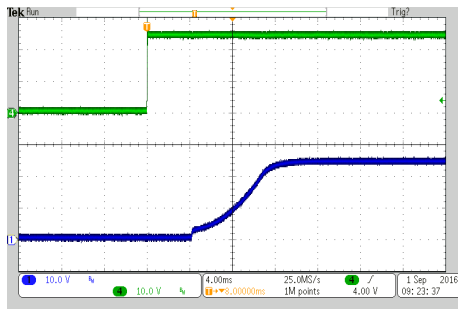

Typical Input Start-Up and Output Rise Characteristic
 $V_{in}=V_{in\ nom}$; Full Load

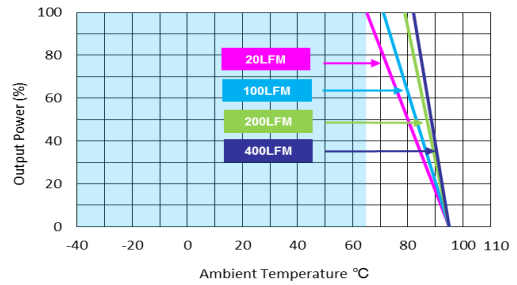

Derating Output Power Versus Ambient Temperature and Airflow
 $V_{in}=V_{in\ nom}$

Characteristic Curves

All test conditions are at 25°C The figures are identical for MKW20-24D12M

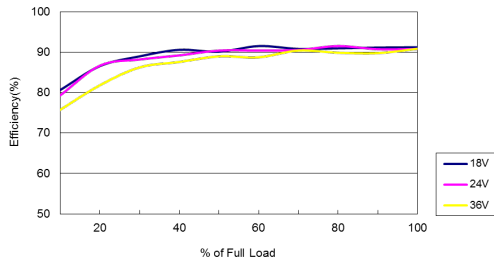

Efficiency Versus Output Current

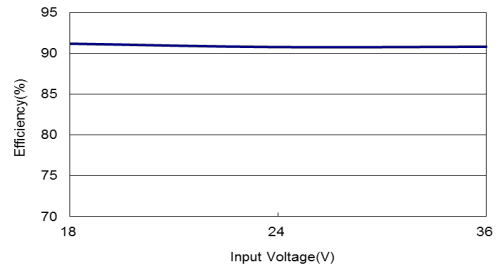

Efficiency Versus Input Voltage Full Load

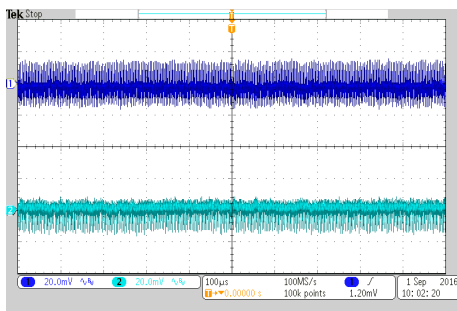

Typical Output Ripple and Noise
 $V_{in}=V_{in\ nom}$; Full Load

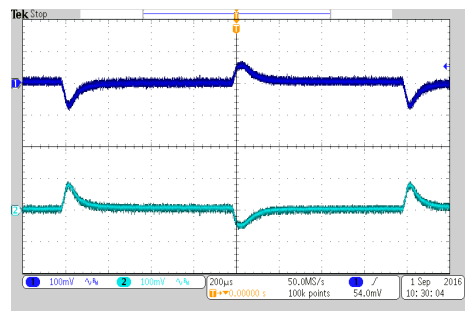

Transient Response to Dynamic Load Change
from 100% to 75% of Full Load ; $V_{in}=V_{in\ nom}$

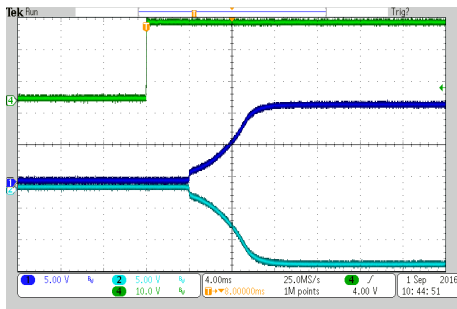

Typical Input Start-Up and Output Rise Characteristic
 $V_{in}=V_{in\ nom}$; Full Load

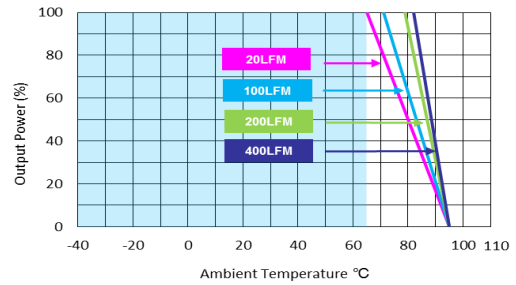

Derating Output Power Versus Ambient Temperature and Airflow
 $V_{in}=V_{in\ nom}$

Characteristic Curves

All test conditions are at 25°C The figures are identical for MKW20-24D15M

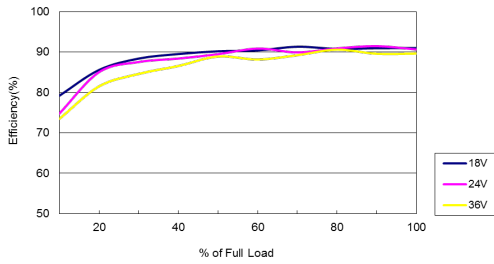

Efficiency Versus Output Current

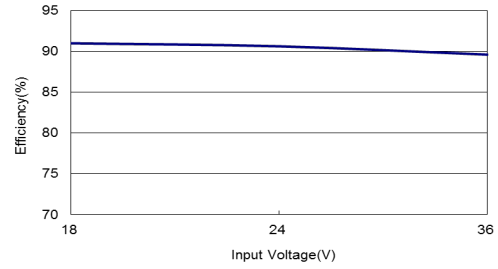

Efficiency Versus Input Voltage Full Load

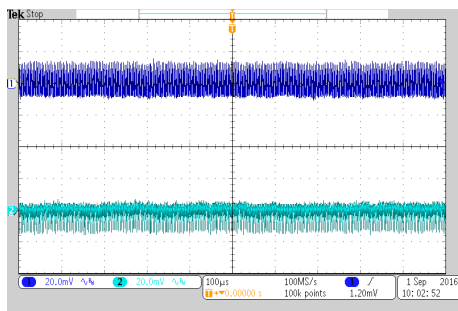

Typical Output Ripple and Noise
 $V_{in}=V_{in\ nom}$; Full Load

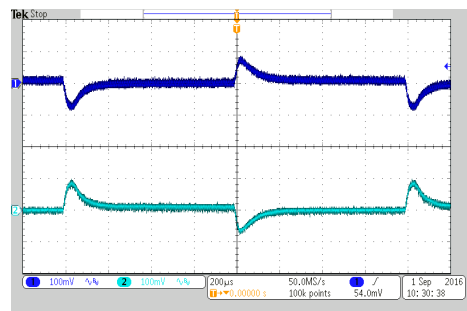

Transient Response to Dynamic Load Change
from 100% to 75% of Full Load ; $V_{in}=V_{in\ nom}$

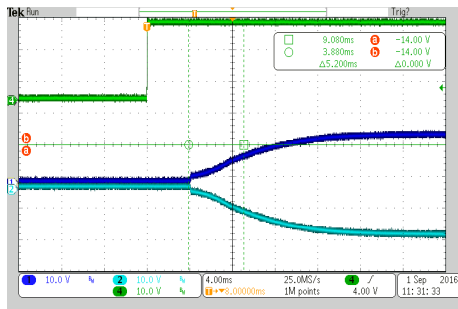

Typical Input Start-Up and Output Rise Characteristic
 $V_{in}=V_{in\ nom}$; Full Load

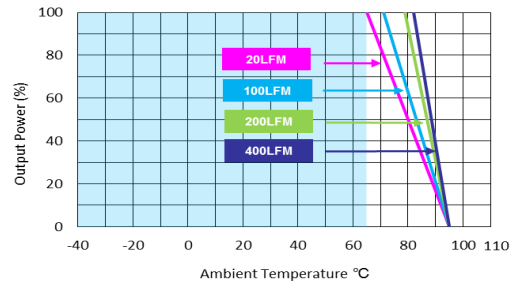

Derating Output Power Versus Ambient Temperature and Airflow
 $V_{in}=V_{in\ nom}$

Characteristic Curves

All test conditions are at 25°C. The figures are identical for MKW20-48S05M

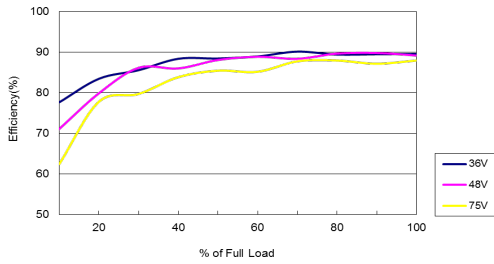

Efficiency Versus Output Current

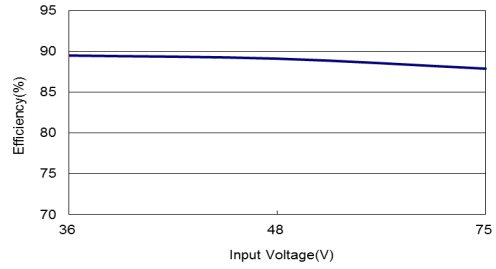

Efficiency Versus Input Voltage Full Load

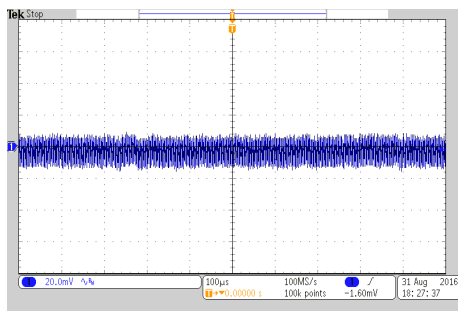

Typical Output Ripple and Noise
 $V_{in}=V_{in\ nom}$; Full Load

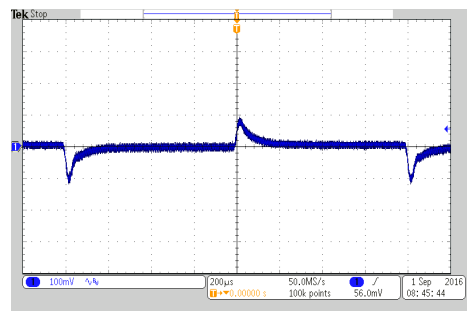

Transient Response to Dynamic Load Change from 100% to 75% of Full Load ; $V_{in}=V_{in\ nom}$

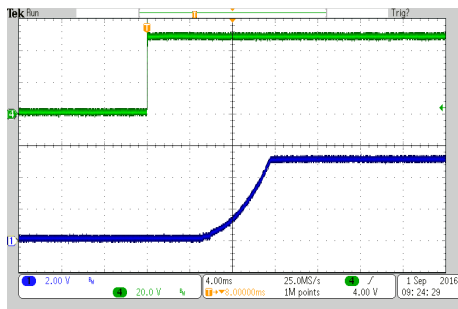

Typical Input Start-Up and Output Rise Characteristic
 $V_{in}=V_{in\ nom}$; Full Load

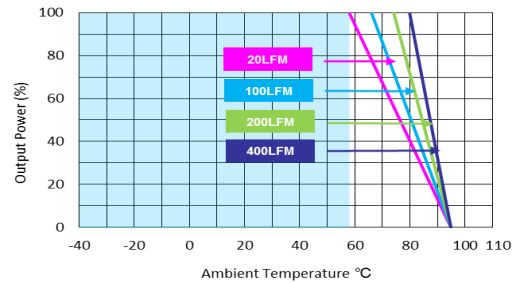

Derating Output Power Versus Ambient Temperature and Airflow
 $V_{in}=V_{in\ nom}$

Characteristic Curves

All test conditions are at 25°C. The figures are identical for MKW20-48S051M

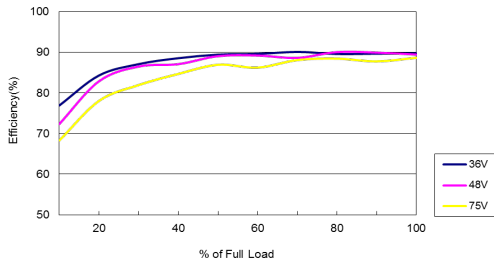

Efficiency Versus Output Current

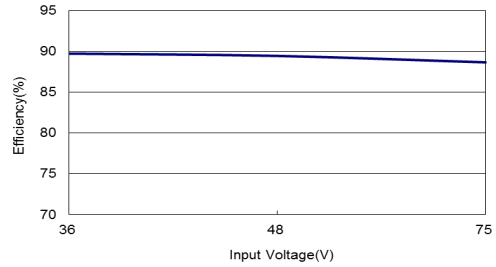

Efficiency Versus Input Voltage Full Load

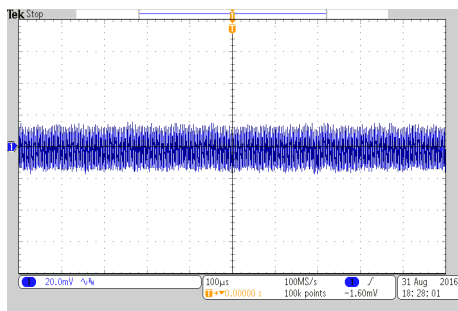

Typical Output Ripple and Noise
 $V_{in}=V_{in\ nom}$; Full Load

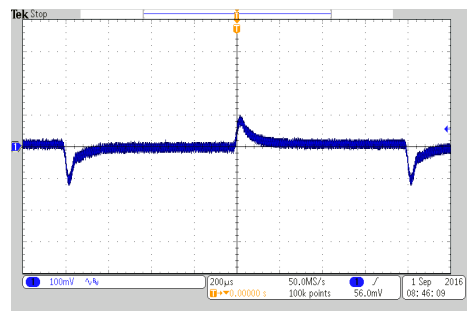

Transient Response to Dynamic Load Change from 100% to 75% of Full Load; $V_{in}=V_{in\ nom}$

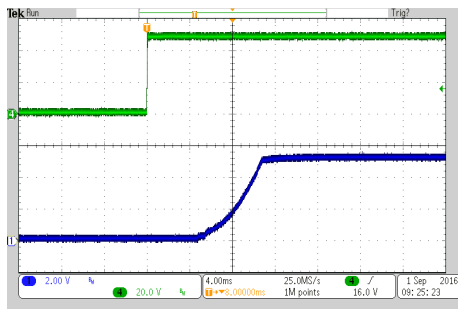

Typical Input Start-Up and Output Rise Characteristic
 $V_{in}=V_{in\ nom}$; Full Load

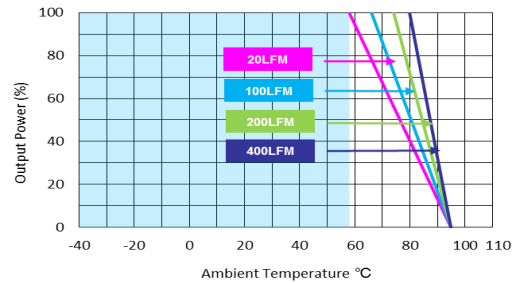

Derating Output Power Versus Ambient Temperature and Airflow
 $V_{in}=V_{in\ nom}$

Characteristic Curves

All test conditions are at 25°C The figures are identical for MKW20-48S12M

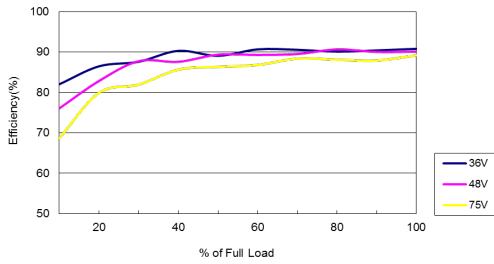

Efficiency Versus Output Current

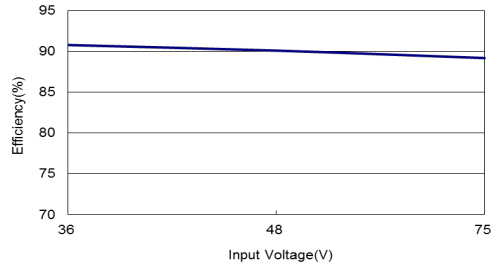

Efficiency Versus Input Voltage Full Load

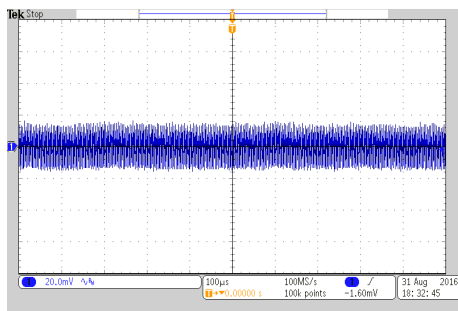

Typical Output Ripple and Noise
 $V_{in}=V_{in\ nom}$; Full Load

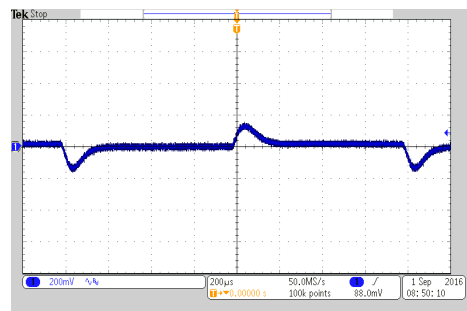

Transient Response to Dynamic Load Change
from 100% to 75% of Full Load ; $V_{in}=V_{in\ nom}$

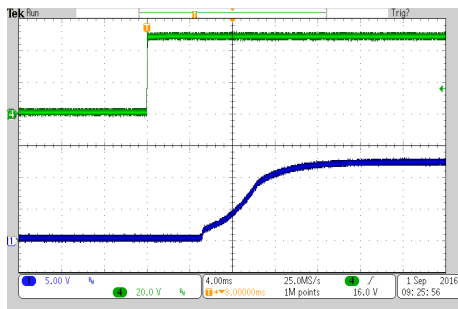

Typical Input Start-Up and Output Rise Characteristic
 $V_{in}=V_{in\ nom}$; Full Load

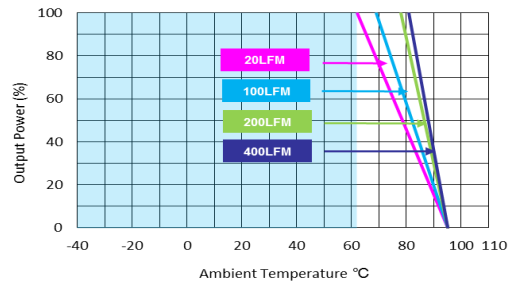

Derating Output Power Versus Ambient Temperature and Airflow
 $V_{in}=V_{in\ nom}$

Characteristic Curves

All test conditions are at 25°C. The figures are identical for MKW20-48S15M

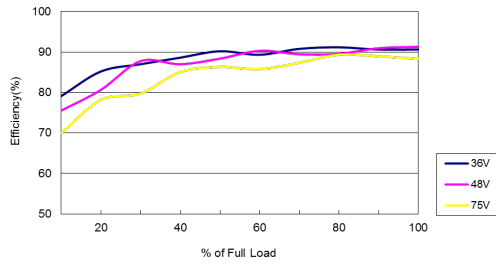

Efficiency Versus Output Current

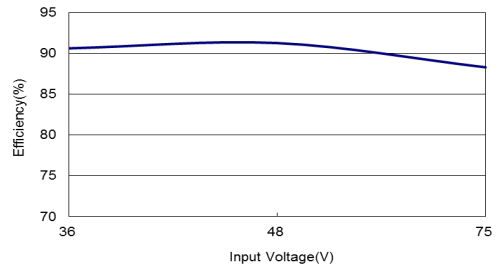

Efficiency Versus Input Voltage
Full Load

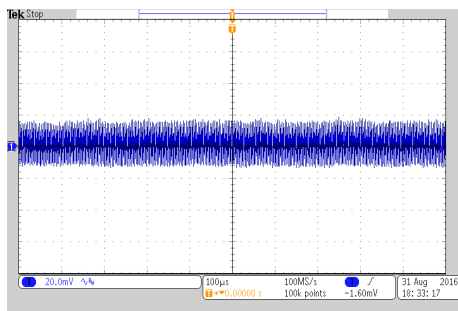

Typical Output Ripple and Noise
 $V_{in}=V_{in\ nom}$; Full Load

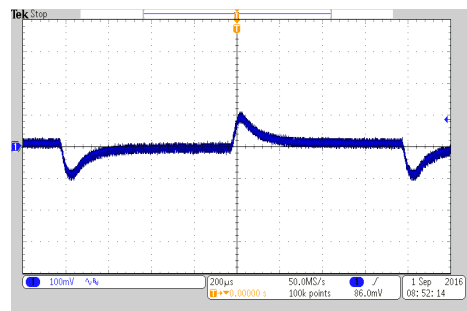

Transient Response to Dynamic Load Change
from 100% to 75% of Full Load; $V_{in}=V_{in\ nom}$

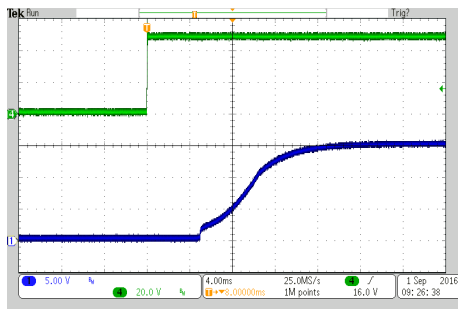

Typical Input Start-Up and Output Rise Characteristic
 $V_{in}=V_{in\ nom}$; Full Load

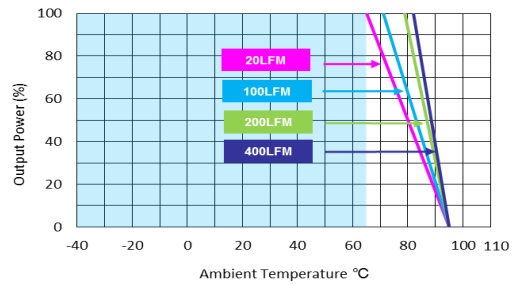

Derating Output Power Versus Ambient Temperature and Airflow
 $V_{in}=V_{in\ nom}$

Characteristic Curves

All test conditions are at 25°C. The figures are identical for MKW20-48S24M

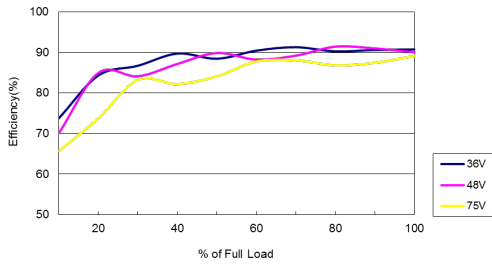

Efficiency Versus Output Current

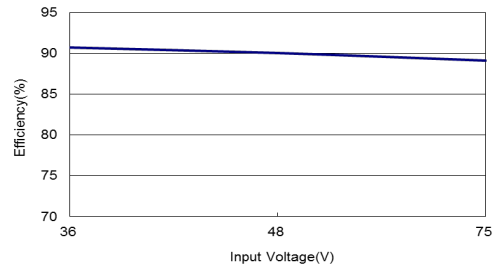

Efficiency Versus Input Voltage Full Load

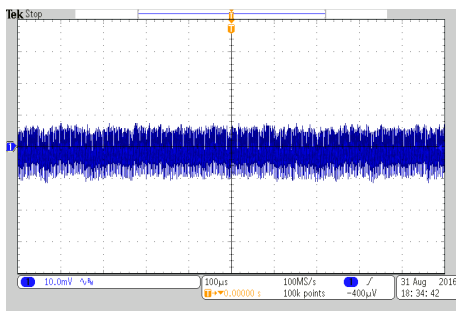

Typical Output Ripple and Noise
 $V_{in}=V_{in\ nom}$; Full Load

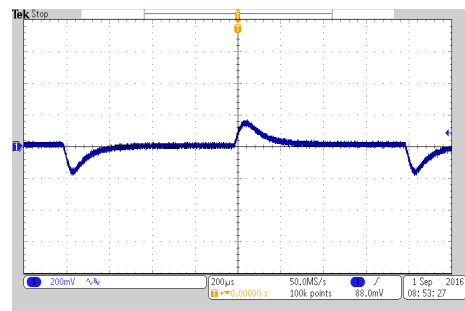

Transient Response to Dynamic Load Change
from 100% to 75% of Full Load; $V_{in}=V_{in\ nom}$

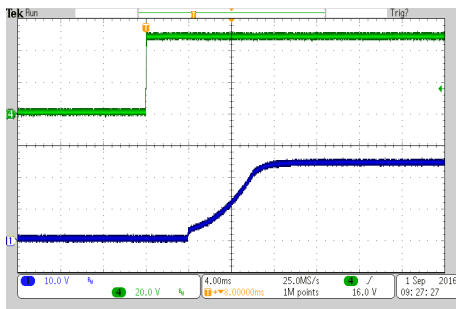

Typical Input Start-Up and Output Rise Characteristic
 $V_{in}=V_{in\ nom}$; Full Load

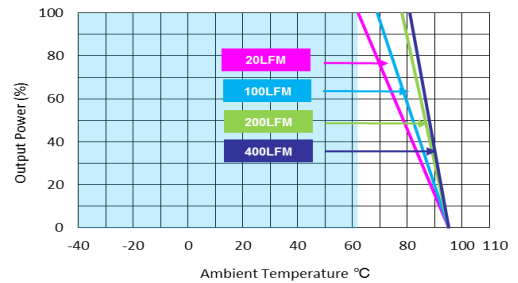

Derating Output Power Versus Ambient Temperature and Airflow
 $V_{in}=V_{in\ nom}$

Characteristic Curves

All test conditions are at 25°C The figures are identical for MKW20-48D12M

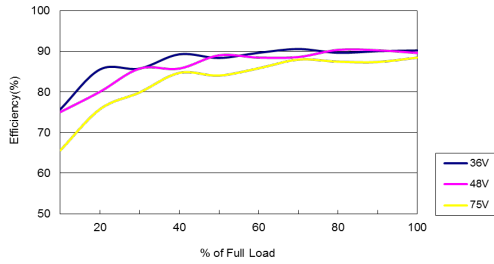

Efficiency Versus Output Current

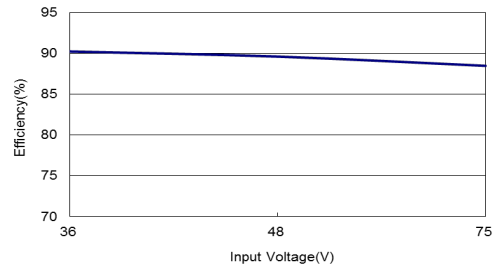

Efficiency Versus Input Voltage Full Load

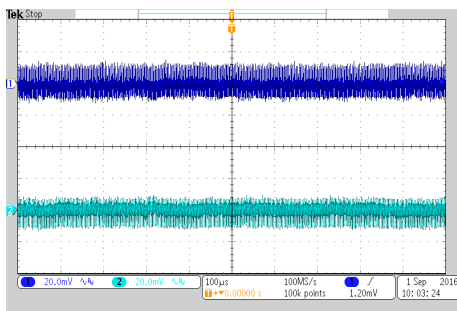

Typical Output Ripple and Noise
 $V_{in}=V_{in\ nom}$; Full Load

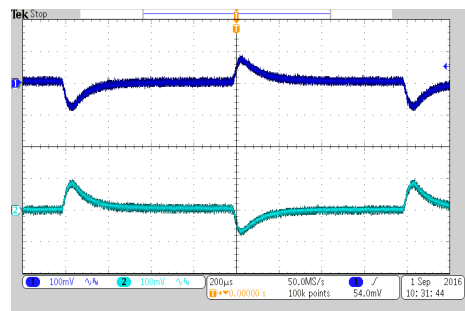

Transient Response to Dynamic Load Change
from 100% to 75% of Full Load ; $V_{in}=V_{in\ nom}$

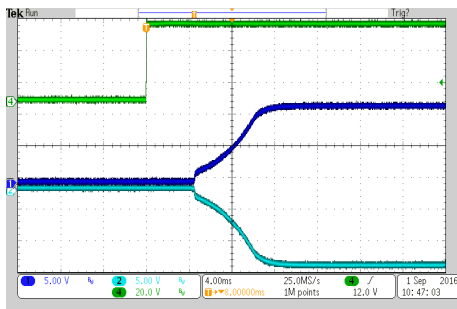

Typical Input Start-Up and Output Rise Characteristic
 $V_{in}=V_{in\ nom}$; Full Load

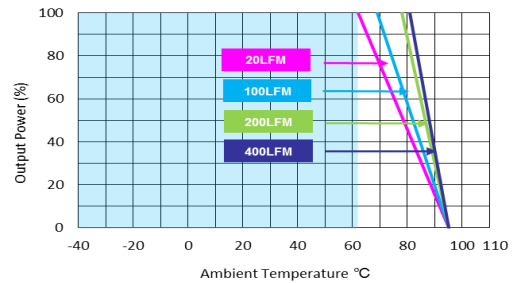

Derating Output Power Versus Ambient Temperature and Airflow
 $V_{in}=V_{in\ nom}$

Characteristic Curves

All test conditions are at 25°C. The figures are identical for MKW20-48D15M

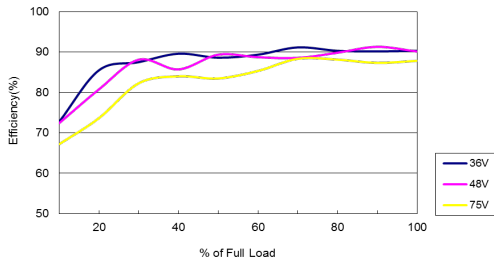

Efficiency Versus Output Current

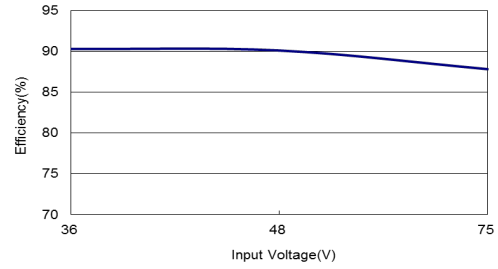

Efficiency Versus Input Voltage
Full Load

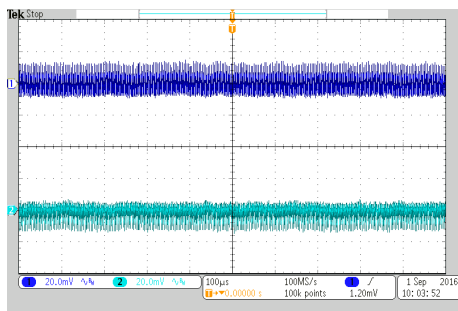

Typical Output Ripple and Noise
 $V_{in}=V_{in\ nom}$; Full Load

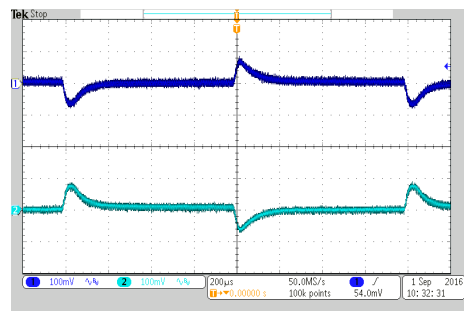

Transient Response to Dynamic Load Change
from 100% to 75% of Full Load ; $V_{in}=V_{in\ nom}$

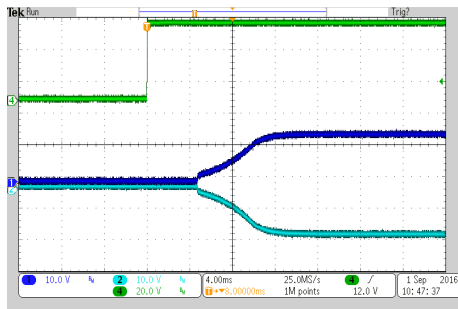

Typical Input Start-Up and Output Rise Characteristic
 $V_{in}=V_{in\ nom}$; Full Load

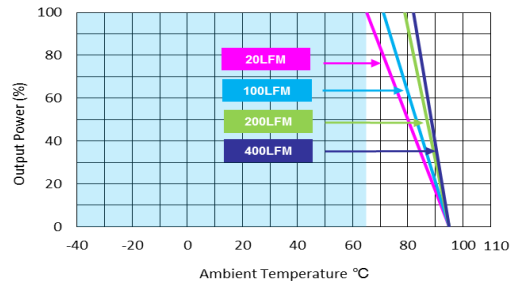

Derating Output Power Versus Ambient Temperature and Airflow
 $V_{in}=V_{in\ nom}$

Package Specifications

Mechanical Dimensions

Pin Connections

Pin	Single Output	Dual Output
1	+Vin	+Vin
2	-Vin	-Vin
3	+Vout	+Vout
4	No Pin	Common
5	-Vout	-Vout

- ▶ All dimensions in mm (inches)
- ▶ Tolerance: X.X±0.5 (X.XX±0.02)
X.XX±0.25 (X.XXX±0.01)
- ▶ Pin diameter $\varnothing 1.0 \pm 0.05$ (0.04±0.002)

Physical Characteristics

Case Size	: 50.8x25.4x12.0mm (2.0x1.0x0.47 inches)
Case Material	: Non-Conductive Black Plastic (flammability to UL 94V-0 rated)
Pin Material	: Copper Alloy with Tin Plate Over Nickel Subplate
Weight	: 30g

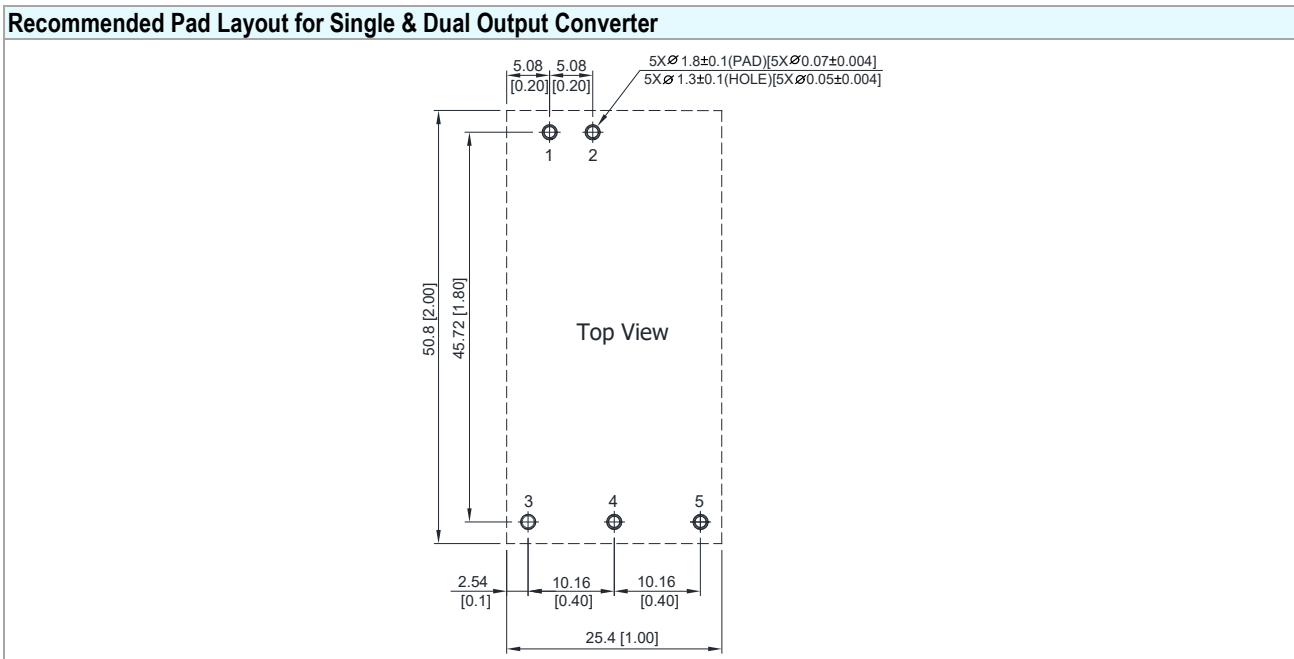

Test Setup

Input Reflected-Ripple Current Test Setup

Input reflected-ripple current is measured with an inductor L_{in} ($4.7\mu H$) and C_{in} ($220\mu F$, $ESR < 1.0\Omega$ at 100 kHz) to simulate source impedance. Capacitor C_{in} , offsets possible battery impedance. Current ripple is measured at the input terminals of the module, measurement bandwidth is $0\text{-}500\text{ kHz}$.

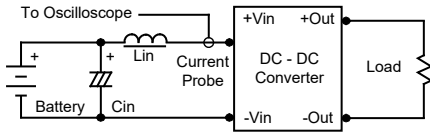

Peak-to-Peak Output Noise Measurement Test

Use a C_{out} $4.7\mu F$ ceramic capacitor. Scope measurement should be made by using a BNC socket, measurement bandwidth is $0\text{-}20\text{ MHz}$. Position the load between 50 mm and 75 mm from the DC-DC Converter.

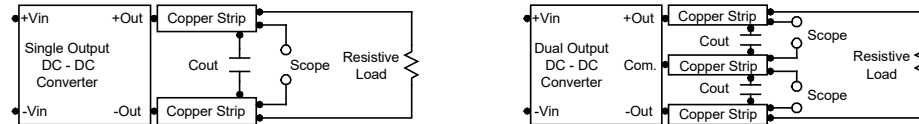

Technical Notes

Overload Protection

To provide hiccup mode protection in a fault (output overload) condition, the unit is equipped with internal current limiting circuitry and can endure overload for an unlimited duration.

Overvoltage Protection

The output overvoltage clamp consists of control circuitry, which is independent of the primary regulation loop, that monitors the voltage on the output terminals. The control loop of the clamp has a higher voltage set point than the primary loop. This provides a redundant voltage control that reduces the risk of output overvoltage. The OVP level can be found in the output data.

Input Source Impedance

The power module should be connected to a low ac-impedance input source. Highly inductive source impedances can affect the stability of the power module. In applications where power is supplied over long lines and output loading is high, it may be necessary to use a capacitor on the input to insure startup. By using a good quality low Equivalent Series Resistance ($ESR < 1.0\Omega$ at 100 kHz) capacitor of a $10\mu F$ for the 12V input devices and a $4.7\mu F$ for the 24V input devices and a $2.2\mu F$ for the 48V devices, capacitor mounted close to the power module helps ensure stability of the unit.

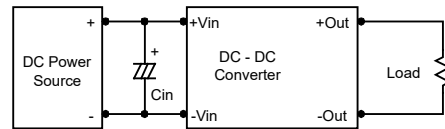

Output Ripple Reduction

A good quality low ESR capacitor placed as close as practicable across the load will give the best ripple and noise performance. To reduce output ripple, it is recommended to use $4.7\mu F$ capacitors at the output.

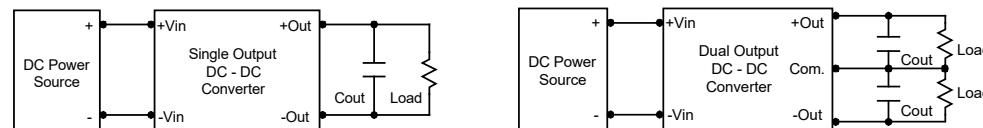

Maximum Capacitive Load

The MKW20M series has limitation of maximum connected capacitance on the output. The power module may operate in current limiting mode during start-up, affecting the ramp-up and the startup time. Connect capacitors at the point of load for best performance. The maximum capacitance can be found in the data sheet.

Thermal Considerations

Many conditions affect the thermal performance of the power module, such as orientation, airflow over the module and board spacing. To avoid exceeding the maximum temperature rating of the components inside the power module, the case temperature must be kept below $95^\circ C$. The derating curves are determined from measurements obtained in a test setup.

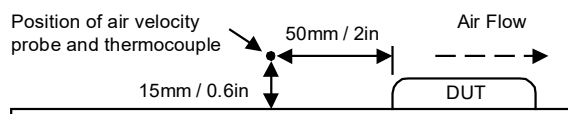

Packaging Information

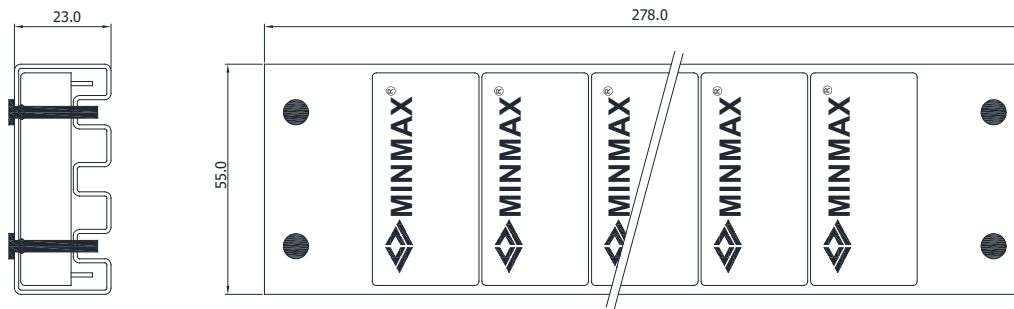

Wave Soldering Considerations

Lead free wave solder profile

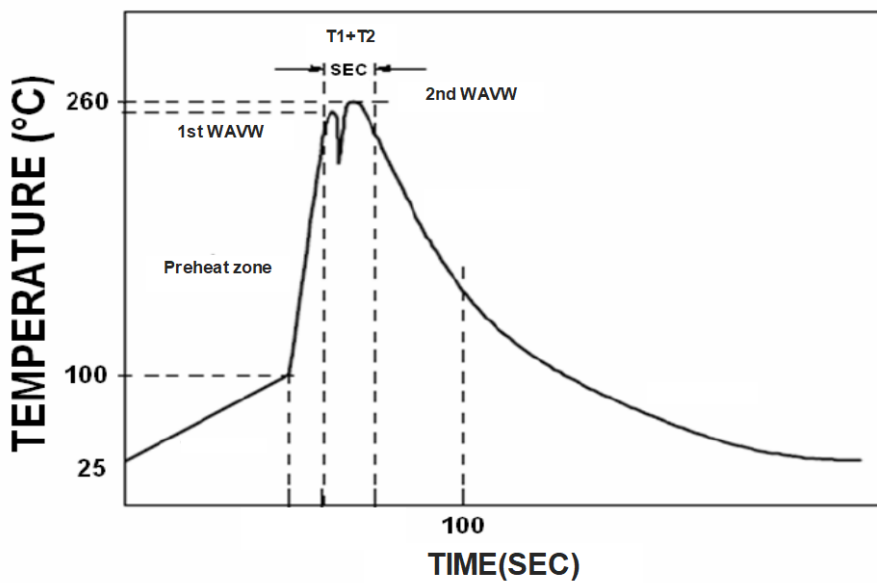

Profile Feature	Reference Parameter
Heating rate during preheat	Rise temp. speed : 3°C/sec max.
Final preheat temperature	Preheat temp. : 100~130°C
Peak temperature	Peak temp. : 250~260°C
Time within peak temperature	Peak time(T1+T2) : 4~6 sec

Reference Solder: Sn-Ag-Cu : Sn-Cu : Sn-Ag

Hand Welding: Soldering iron : Power 60W

Welding Time: 2~4 sec

Temp.: 380~400°C

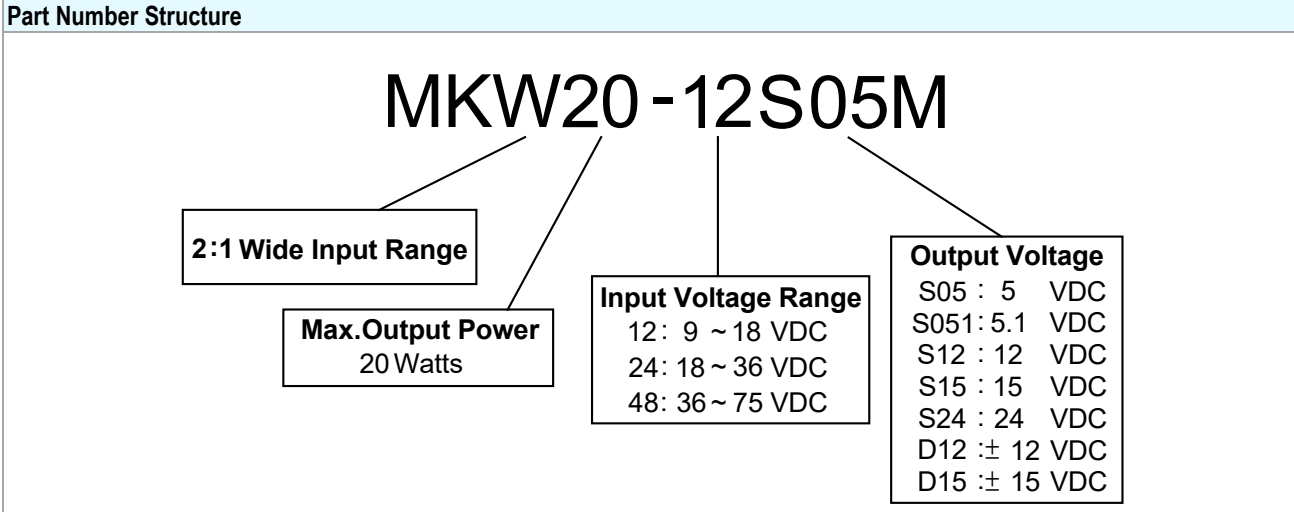

MTBF and Reliability

The MTBF of MKW20M series of DC-DC converters has been calculated using

MIL-HDBK 217F NOTICE2, Operating Temperature 25°C, Ground Benign.

Model	MTBF	Unit
MKW20-12S05M	1,087,344	Hours
MKW20-12S051M	1,087,344	
MKW20-12S12M	1,598,916	
MKW20-12S15M	1,655,302	
MKW20-12S24M	1,565,185	
MKW20-12D12M	1,565,185	
MKW20-12D15M	1,758,649	
MKW20-24S05M	1,308,922	
MKW20-24S051M	1,308,922	
MKW20-24S12M	1,639,993	
MKW20-24S15M	1,691,078	
MKW20-24S24M	1,708,823	
MKW20-24D12M	1,708,823	
MKW20-24D15M	1,780,647	
MKW20-48S05M	1,419,400	
MKW20-48S051M	1,419,400	
MKW20-48S12M	1,641,012	
MKW20-48S15M	1,692,282	
MKW20-48S24M	1,474,814	
MKW20-48D12M	1,474,814	
MKW20-48D15M	1,793,561	