

**FEATURES**

- ▶ Smallest Encapsulated 25W Converter
- ▶ Ultra-compact 1" X 1" Package
- ▶ Ultra-wide 4:1 Input Voltage Range
- ▶ Fully Regulated Output Voltage
- ▶ Excellent Efficiency up to 90%
- ▶ I/O Isolation 1500 VDC
- ▶ Operating Ambient Temp. Range -40°C to +80°C
- ▶ No Min. Load Requirement
- ▶ Overload/Voltage and Short Circuit Protection
- ▶ Remote On/Off Control, Output Voltage Trim
- ▶ Shielded Metal Case with Insulated Baseplate
- ▶ UL/cUL/IEC/EN 60950-1 Safety Approval & CE Marking

**PRODUCT OVERVIEW**

The MINMAX MJWI25 series is the latest range of a new generation of high performance dc-dc converter modules with very high power density. The product offers fully 25W in a shielded metal package with dimensions of just 1.0"x1.0"x0.4". All models provide ultra-wide 4:1 input range and tightly regulated output voltage. State-of-the-art circuit topology provides a very high efficiency up to 90% which allows an operating temperature range of -40°C to +80°C. These converters are qualified for demanding applications in battery operated equipment, instrumentation, data communication, industrial and many other space critical applications.

**Model Selection Guide**

Model Number	Input Voltage (Range)	Output Voltage	Output Current	Input Current		Reflected Ripple Current	Over Voltage Protection	Max. capacitive Load	Efficiency (typ.)
				Max.	@Max. Load				@No Load
			VDC	VDC	mA				mA(typ.)
MJWI25-24S033	24 (9 ~ 36)	3.3	6000	950	85	50	3.9	10300	87
MJWI25-24S05		5	5000	1170	85		6.2	6800	89
MJWI25-24S12		12	2090	1175	85		15	1200	89
MJWI25-24S15		15	1670	1160	85		18	750	90
MJWI25-24D12		±12	±1040	1170	85		±15	680#	89
MJWI25-24D15		±15	±840	1180	85		±18	380#	89
MJWI25-48S033	48 (18 ~ 75)	3.3	6000	470	45	30	3.9	10300	88
MJWI25-48S05		5	5000	580	45		6.2	6800	90
MJWI25-48S12		12	2090	580	45		15	1200	90
MJWI25-48S15		15	1670	580	45		18	750	90
MJWI25-48D12		±12	±1040	585	45		±15	680#	89
MJWI25-48D15		±15	±840	590	45		±18	380#	89

# For each output

**Input Specifications**

Parameter	Conditions / Model	Min.	Typ.	Max.	Unit
Input Surge Voltage (100ms max.)	24V Input Models	-0.7	---	50	VDC
	48V Input Models	-0.7	---	100	
Start-Up Threshold Voltage	24V Input Models	---	---	9	
	48V Input Models	---	---	18	
Start Up Time	Power Up	---	---	30	ms
	Remote On/Off	---	---	30	ms
Input Filter	All Models	Internal LC Type			

Remote On/Off Control					
Parameter	Conditions	Min.	Typ.	Max.	Unit
Converter On	3.5V ~ 12V or Open Circuit				
Converter Off	0V ~ 1.2V or Short Circuit				
Control Input Current (on)	Vctrl = 5.0V	---	---	0.5	mA
Control Input Current (off)	Vctrl = 0V	---	---	-0.5	mA
Control Common	Referenced to Negative Input				
Standby Input Current	Supply Off & Nominal Vin	---	3	---	mA

Output Specifications						
Parameter	Conditions / Model	Min.	Typ.	Max.	Unit	
Output Voltage Setting Accuracy		---	---	±1.0	%Vnom.	
Output Voltage Balance	Dual Output, Balanced Loads	---	---	±2.0	%	
Line Regulation	Vin=Min. to Max. @Full Load	---	---	±0.2	%	
Load Regulation	Io=0% to 100%	Single Output	---	---	±0.2	%
		Dual Output	---	---	±1.0	%
Cross Regulation (Dual)	Asymmetrical load 25% / 100% FL	---	---	±5.0	%	
Minimum Load	No minimum Load Requirement					
Ripple & Noise	0-20 MHz Bandwidth	3.3V & 5V Models	---	---	100	mV <sub>P-P</sub>
		12V, 15V & Dual Models	---	---	150	mV <sub>P-P</sub>
Transient Recovery Time	25% Load Step Change	---	250	---	μsec	
Transient Response Deviation		---	±3	±5	%	
Temperature Coefficient		---	---	±0.02	%/°C	
Trim Up / Down Range (See Page 9)	% of Nominal Output Voltage	---	---	±10	%	
Over Load Protection	Hiccup	---	150	---	%	
Short Circuit Protection	Hiccup Mode 0.6 Hz typ., Automatic Recovery					

General Specifications					
Parameter	Conditions	Min.	Typ.	Max.	Unit
I/O Isolation Voltage	60 Seconds	1500	---	---	VDC
	1 Second	1800	---	---	VDC
I/O Isolation Resistance	500 VDC	1000	---	---	MΩ
I/O Isolation Capacitance	100KHz, 1V	---	---	2000	pF
Switching Frequency		---	285	---	KHz
MTBF(calculated)	MIL-HDBK-217F@25°C, Ground Benign	444,000			Hours
Safety Approvals	UL/cUL 60950-1 recognition (CSA certificate), IEC/EN 60950-1 (CB-report)				

**Environmental Specifications**

Parameter	Conditions/Model	Min.	Max.		Unit
			without Heatsink	with Heatsink	
Operating Ambient Temperature Range Natural Convection <sup>(7)</sup> Nominal Vin, Load 100% Inom. (for Power Derating see relative Derating Curves)	MJWI25-48S033	-40	57	65	°C
	MJWI25-24S15, MJWI25-48S05 MJWI25-48S12, MJWI25-48S15		56	64	
	MJWI25-24S033		53	61	
	MJWI25-24S05, MJWI25-24S12 MJWI25-24D12, MJWI25-24D15 MJWI25-48D12, MJWI25-48D15		50	59	
Thermal Impedance	Natural Convection without Heatsink	17.6	---	---	°C/W
	Natural Convection with Heatsink	14.8	---	---	°C/W
	100LFM Convection without Heatsink	13.6	---	---	°C/W
	100LFM Convection with Heatsink	8.5	---	---	°C/W
	200LFM Convection without Heatsink	11.8	---	---	°C/W
	200LFM Convection with Heatsink	6.5	---	---	°C/W
	400LFM Convection without Heatsink	8.8	---	---	°C/W
400LFM Convection with Heatsink	4.3	---	---	°C/W	
Case Temperature		---	+105	---	°C
Storage Temperature Range		-50	+125	---	°C
Humidity (non condensing)		---	95	---	% rel. H
Cooling	Natural Convection				
RFI	Six-Sided shielded, Metal Case				
Lead Temperature (1.5mm from case for 10Sec.)		---	260	---	°C

**EMC Specifications**

Parameter	Standards & Level		Performance
EMI	Conduction	EN55032, FCC part 15	Class A, Class B
EMS	EN55024		
	ESD	EN61000-4-2 Air ± 8kV, Contact ± 6kV	A
	Radiated immunity	EN61000-4-3 10V/m	A
	Fast transient <sup>(8)</sup>	EN61000-4-4 ±2kV	A
	Surge <sup>(6)</sup>	EN61000-4-5 ±1kV	A
	Conducted immunity	EN61000-4-6 10Vrms	A

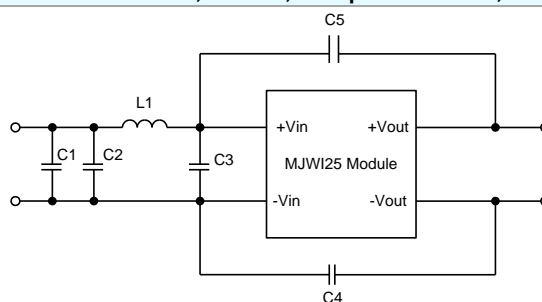
**External Filter meets Conducted EMI EN55032 class A, class B; FCC part 15 level A, level B**

Class	Model	C1	C2	C3	C4&C5	L1
Class A	MJWI25-24XXX	None	3.3μF/50V 1210 MLCC	None	None	2.2μH
	MJWI25-48XXX	None	3.3μF/100V 1210 MLCC	None	None	4.7μH
Class B	MJWI25-24XXX	3.3μF/50V 1210 MLCC	3.3μF/50V 1210 MLCC	3.3μF/50V 1210 MLCC	1800 pF/2KV 1206 MLCC	2.2μH
	MJWI25-48XXX	3.3μF/100V 1210 MLCC	3.3μF/100V 1210 MLCC	3.3μF/100V 1210 MLCC	1800 pF/2KV 1206 MLCC	4.7μH

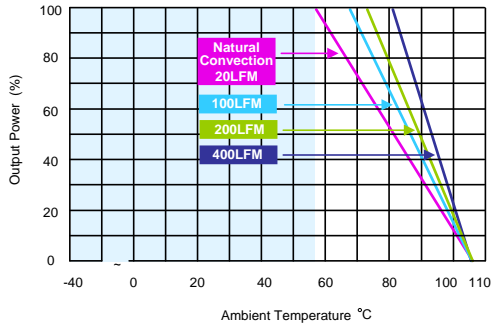
**Power Derating Curve**

MJWI25-48S033 Derating Curve without Heatsink

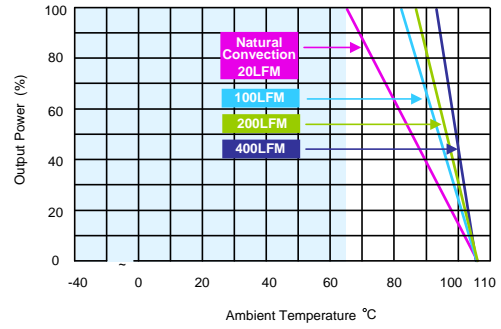

MJWI25-48S033 Derating Curve with Heatsink

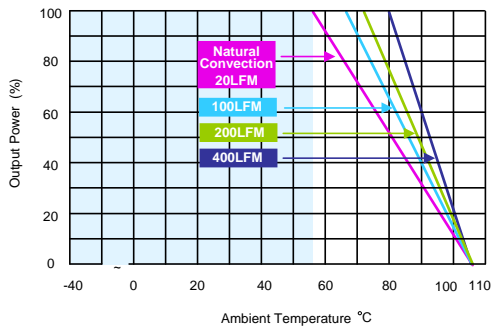

MJWI25-24S15, MJWI25-48S05, MJWI25-48S12, MJWI25-48S15 Derating Curve without Heatsink

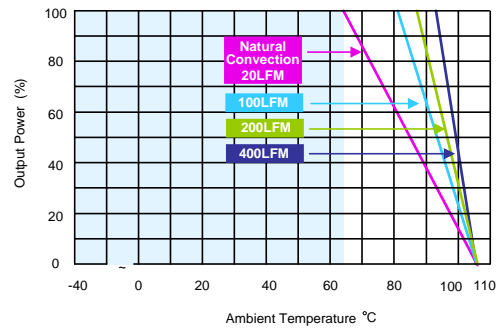

MJWI25-24S15, MJWI25-48S05, MJWI25-48S12, MJWI25-48S15 Derating Curve with Heatsink

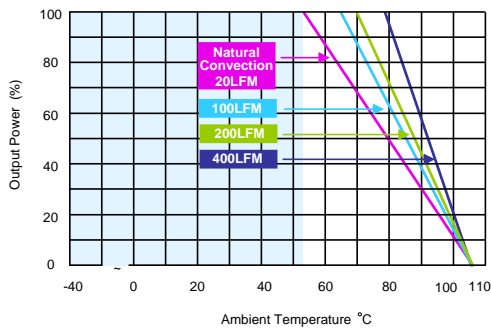

MJWI25-24S033 Derating Curve without Heatsink

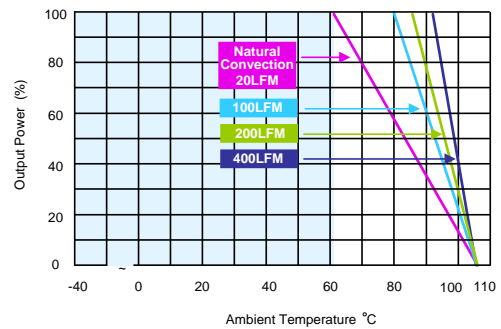

MJWI25-24S033 Derating Curve with Heatsink

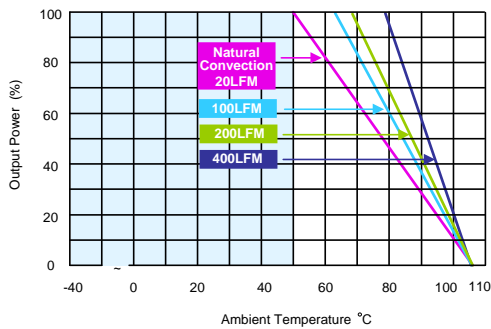

MJWI25-24S05, MJWI25-24S12, MJWI25-24D12, MJWI25-24D15, MJWI25-48D12, MJWI25-48D15 Derating Curve without Heatsink

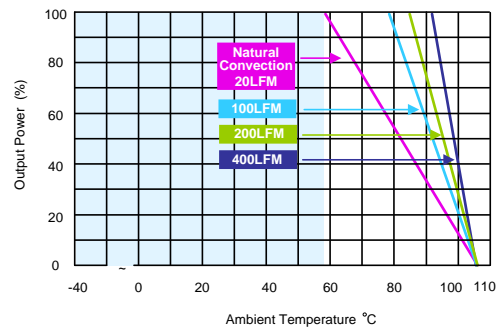

MJWI25-24S05, MJWI25-24S12, MJWI25-24D12, MJWI25-24D15, MJWI25-48D12, MJWI25-48D15 Derating Curve with Heatsink

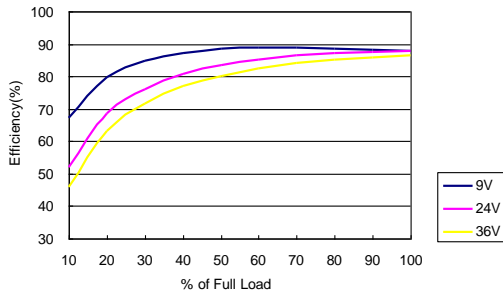
**Efficiency Curve @25°C**

MJWI25-24S033 Efficiency vs Load Current

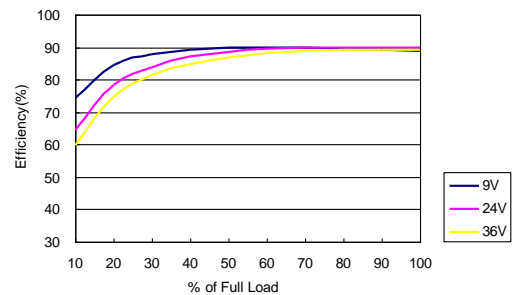

MJWI25-24S05 Efficiency vs Load Current

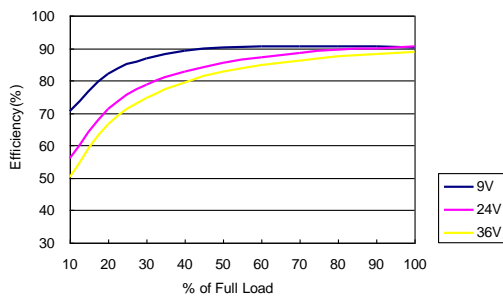

MJWI25-24S12 Efficiency vs Load Current

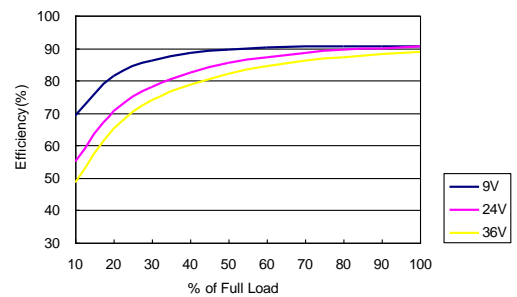

MJWI25-24S15 Efficiency vs Load Current

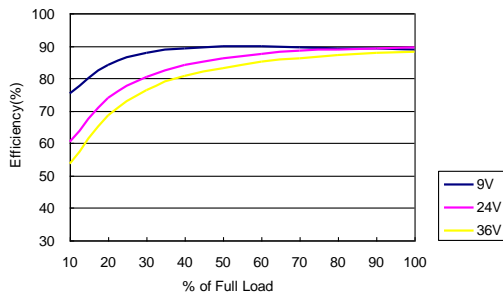

MJWI25-24D12 Efficiency vs Load Current

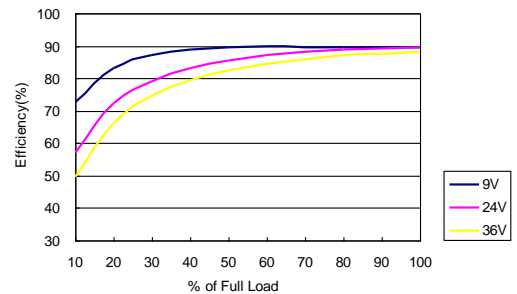

MJWI25-24D15 Efficiency vs Load Current

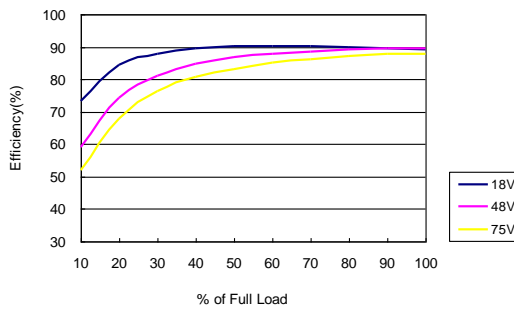

MJWI25-48S033 Efficiency vs Load Current

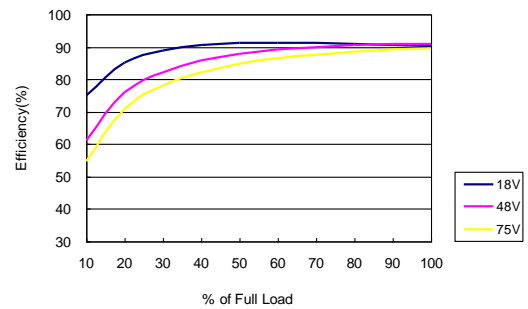

MJWI25-48S05 Efficiency vs Load Current

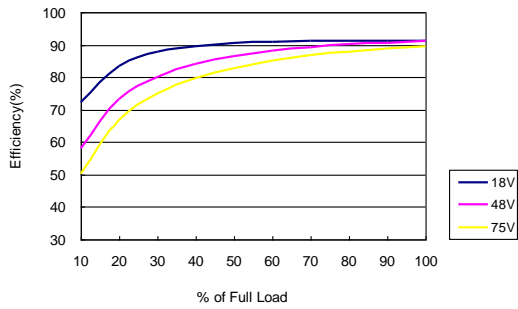
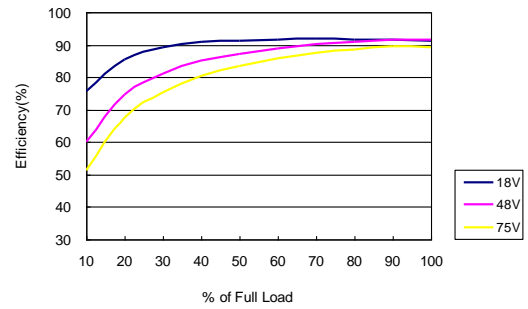
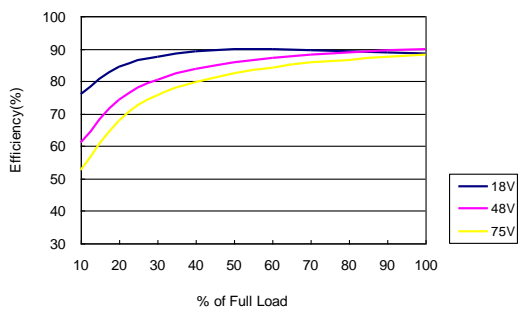
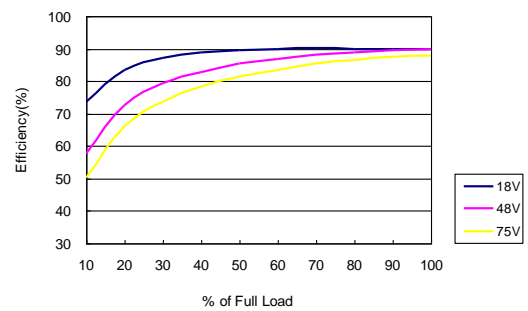
**Efficiency Curve @25°C**

**MJWI25-48S12 Efficiency vs Load Current**

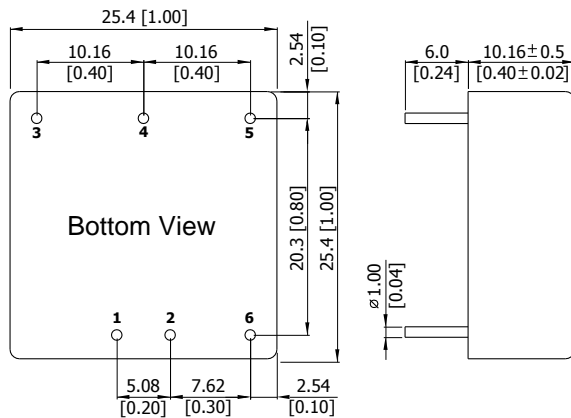
**MJWI25-48S15 Efficiency vs Load Current**

**MJWI25-48D12 Efficiency vs Load Current**

**MJWI25-48D15 Efficiency vs Load Current**
**Notes**

- 1 Specifications typical at Ta=+25°C, resistive load, nominal input voltage, rated output current unless otherwise noted.
- 2 Transient recovery time is measured to within 1% error band for a step change in output load of 75% to 100%.
- 3 Ripple & Noise measurement with a 1μF MLCC and a 10μF Tantalum Capacitor.
- 4 We recommend to protect the converter by a slow blow fuse in the input supply line.
- 5 Other input and output voltage may be available, please contact factory.
- 6 To meet EN61000-4-4 & EN61000-4-5 an external capacitor across the input pins is required. Suggested capacitor : 220μF/100V.
- 7 That "natural convection" is about 20LFM but is not equal to still air (0 LFM).
- 8 Specifications are subject to change without notice.

**Package Specifications**
**Mechanical Dimensions**

**Pin Connections**

Pin	Single Output	Dual Output
1	+Vin	+Vin
2	-Vin	-Vin
3	+Vout	+Vout
4	Trim	Common
5	-Vout	-Vout
6	Remote On/Off	Remote On/Off

- ▶ All dimensions in mm (inches)
- ▶ Tolerance: X.X±0.5 (X.XX±0.02)  
X.XX±0.25 (X.XXX±0.01)
- ▶ Pin diameter  $\varnothing 1.0 \pm 0.05$  (0.04±0.002)

**Physical Characteristics**

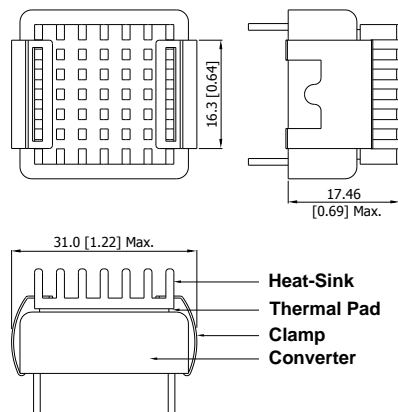
Case Size	: 25.4x25.4x10.16mm (1.0x1.0x0.4 inches)
Case Material	: Aluminium Alloy, Black Anodized Coating
Base Material	: FR4 PCB (flammability to UL 94V-0 rated)
Pin Material	: Copper Alloy with Gold Plate Over Nickel Subplate
Weight	: 16.5g

**Heatsink (Option -HS)**
**Mechanical Dimensions**

Heatsink Material: Aluminum  
Finish: Anodic treatment (black)  
Weight: 2g

- ▶ The advantages of adding a heatsink are:

1. To improve heat dissipation and increase the stability and reliability of the DC/DC converters at high operating temperatures.
2. To increase operating temperature of the DC/DC converter, please refer to Derating Curve.

Order Code Table	
Standard	With heatsink
MJWI25-24S033	MJWI25-24S033-HS
MJWI25-24S05	MJWI25-24S05-HS
MJWI25-24S12	MJWI25-24S12-HS
MJWI25-24S15	MJWI25-24S15-HS
MJWI25-24D12	MJWI25-24D12-HS
MJWI25-24D15	MJWI25-24D15-HS
MJWI25-48S033	MJWI25-48S033-HS
MJWI25-48S05	MJWI25-48S05-HS
MJWI25-48S12	MJWI25-48S12-HS
MJWI25-48S15	MJWI25-48S15-HS
MJWI25-48D12	MJWI25-48D12-HS
MJWI25-48D15	MJWI25-48D15-HS



**External Output Trimming**

Output can be externally trimmed by using the method shown below

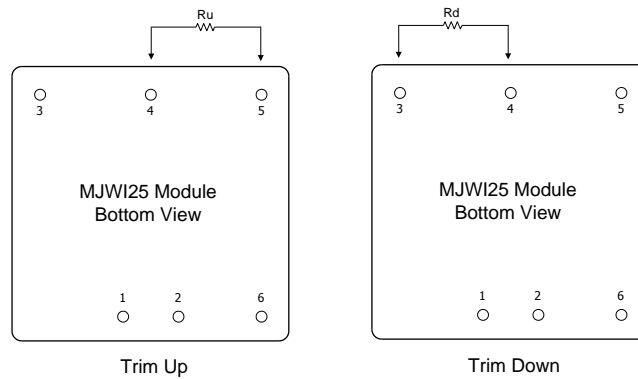

MJWI25-XXS033 Trim Table

Trim down	1	2	3	4	5	6	7	8	9	10	%
Vout=	Vox0.99	Vox0.98	Vox0.97	Vox0.96	Vox0.95	Vox0.94	Vox0.93	Vox0.92	Vox0.91	Vox0.90	Volts
Rd=	72.61	32.55	19.20	12.52	8.51	5.84	3.94	2.51	1.39	0.50	KOhms
Trim up	1	2	3	4	5	6	7	8	9	10	%
Vout=	Vox1.01	Vox1.02	Vox1.03	Vox1.04	Vox1.05	Vox1.06	Vox1.07	Vox1.08	Vox1.09	Vox1.10	Volts
Ru=	60.84	27.40	16.25	10.68	7.34	5.11	3.51	2.32	1.39	0.65	KOhms

MJWI25-XXS05 Trim Table

Trim down	1	2	3	4	5	6	7	8	9	10	%
Vout=	Vox0.99	Vox0.98	Vox0.97	Vox0.96	Vox0.95	Vox0.94	Vox0.93	Vox0.92	Vox0.91	Vox0.90	Volts
Rd=	138.88	62.41	36.92	24.18	16.53	11.44	7.79	5.06	2.94	1.24	KOhms
Trim up	1	2	3	4	5	6	7	8	9	10	%
Vout=	Vox1.01	Vox1.02	Vox1.03	Vox1.04	Vox1.05	Vox1.06	Vox1.07	Vox1.08	Vox1.09	Vox1.10	Volts
Ru=	106.87	47.76	28.06	18.21	12.30	8.36	5.55	3.44	1.79	0.48	KOhms

MJWI25-XXS12 Trim Table

Trim down	1	2	3	4	5	6	7	8	9	10	%
Vout=	Vox0.99	Vox0.98	Vox0.97	Vox0.96	Vox0.95	Vox0.94	Vox0.93	Vox0.92	Vox0.91	Vox0.90	Volts
Rd=	413.55	184.55	108.22	70.05	47.15	31.88	20.98	12.80	6.44	1.35	KOhms
Trim up	1	2	3	4	5	6	7	8	9	10	%
Vout=	Vox1.01	Vox1.02	Vox1.03	Vox1.04	Vox1.05	Vox1.06	Vox1.07	Vox1.08	Vox1.09	Vox1.10	Volts
Ru=	351.00	157.50	93.00	60.75	41.40	28.50	19.29	12.37	7.00	2.70	KOhms

MJWI25-XXS15 Trim Table

Trim down	1	2	3	4	5	6	7	8	9	10	%
Vout=	Vox0.99	Vox0.98	Vox0.97	Vox0.96	Vox0.95	Vox0.94	Vox0.93	Vox0.92	Vox0.91	Vox0.90	Volts
Rd=	530.73	238.61	141.24	92.56	63.35	43.87	29.96	19.53	11.41	4.92	KOhms
Trim up	1	2	3	4	5	6	7	8	9	10	%
Vout=	Vox1.01	Vox1.02	Vox1.03	Vox1.04	Vox1.05	Vox1.06	Vox1.07	Vox1.08	Vox1.09	Vox1.10	Volts
Ru=	422.77	189.89	112.26	73.44	50.15	34.63	23.54	15.22	8.75	3.58	KOhms

## Test Setup

### Input Reflected-Ripple Current Test Setup

Input reflected-ripple current is measured with an inductor  $L_{in}$  (4.7 $\mu$ H) and  $C_{in}$  (220 $\mu$ F, ESR < 1.0 $\Omega$  at 100 KHz) to simulate source impedance. Capacitor  $C_{in}$ , offsets possible battery impedance. Current ripple is measured at the input terminals of the module, measurement bandwidth is 0-500 KHz.

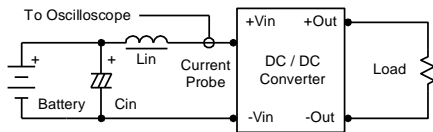

### Peak-to-Peak Output Noise Measurement Test

Use a 1 $\mu$ F ceramic capacitor and a 10 $\mu$ F tantalum capacitor. Scope measurement should be made by using a BNC socket, measurement bandwidth is 0-20 MHz. Position the load between 50 mm and 75 mm from the DC/DC Converter.

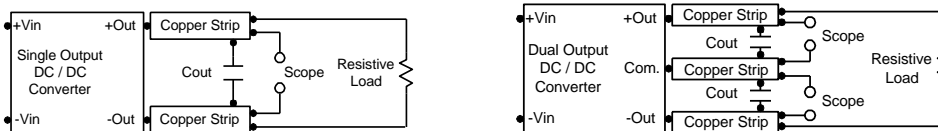

## Technical Notes

### Remote On/Off

Positive logic remote on/off turns the module on during a logic high voltage on the remote on/off pin, and off during a logic low. To turn the power module on and off, the user must supply a switch to control the voltage between the on/off terminal and the -Vin terminal. The switch can be an open collector or equivalent. A logic low is 0V to 1.2V. A logic high is 3.5V to 12V. The maximum sink current at the on/off terminal (Pin 6) during a logic low is -500 $\mu$ A. The maximum allowable leakage current of a switch connected to the on/off terminal (Pin 6) at logic high (3.5V to 12V) is 10mA.

### Overload Protection

To provide hiccup mode protection in a fault (output overload) condition, the unit is equipped with internal current limiting circuitry and can endure overload for an unlimited duration.

### Overvoltage Protection

The output overvoltage clamp consists of control circuitry, which is independent of the primary regulation loop, that monitors the voltage on the output terminals. The control loop of the clamp has a higher voltage set point than the primary loop. This provides a redundant voltage control that reduces the risk of output overvoltage. The OVP level can be found in the output data.

### Input Source Impedance

The power module should be connected to a low ac-impedance input source. Highly inductive source impedances can affect the stability of the power module. In applications where power is supplied over long lines and output loading is high, it may be necessary to use a capacitor at the input to ensure startup. Capacitor mounted close to the power module helps ensure stability of the unit, it is recommended to use a good quality low Equivalent Series Resistance (ESR < 1.0 $\Omega$  at 100 KHz) capacitor of a 10 $\mu$ F for the 24V and 48V devices.

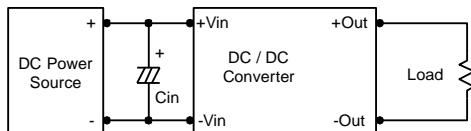

### Output Ripple Reduction

A good quality low ESR capacitor placed as close as practicable across the load will give the best ripple and noise performance. To reduce output ripple, it is recommended to use 4.7 $\mu$ F capacitors at the output.

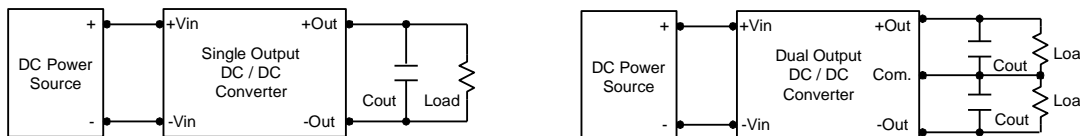

### Maximum Capacitive Load

The MJWI25 series has limitation of maximum connected capacitance at the output. The power module may be operated in current limiting mode during start-up, affecting the ramp-up and the startup time. The maximum capacitance can be found in the data sheet.

### Thermal Considerations

Many conditions affect the thermal performance of the power module, such as orientation, airflow over the module and board spacing. To avoid exceeding the maximum temperature rating of the components inside the power module, the case temperature must be kept below 105 $^{\circ}$ C. The derating curves are determined from measurements obtained in a test setup.

