



MINMAX[®]

MIW10 Series

Electric Characteristic Note

MIW10 Series EC Note

DC-DC CONVERTER 10W, Regulated Output, DIP-Package

Features

- ▶ Industrial Standard DIP-24 Package
- ▶ Wide 2:1 Input Voltage Range
- ▶ Fully Regulated Output Voltage
- ▶ I/O Isolation 1500 VDC
- ▶ Operating Ambient Temp. Range -40°C to +85°C
- ▶ Low No Load Power Consumption
- ▶ No Min. Load Requirement
- ▶ Under-Voltage, Overload and Short Circuit Protection
- ▶ Remote On/Off Control
- ▶ Shielded Metal Case with Insulated Baseplate
- ▶ UL/cUL/IEC/EN 62368-1(60950-1) Safety Approval



Applications

- ▶ Distributed power architectures
- ▶ Workstations
- ▶ Computer equipment
- ▶ Communications equipment

Product Overview

The MINMAX MIW10 series is a range of cost-optimized 10W isolated DC-DC converter within an encapsulated DIP-24 package. There are 21 models available for 12, 24, 48VDC with wide 2:1 input voltage range. By state-of-the-art circuit topology and 89% high efficiency could be achieved allowing an operating temperature of -40°C to +85°C as well as low standby power consumption. Further features include remote ON/OFF, under-voltage, overload, short circuit protection and no min. load requirement as well. These DC-DC converters offer a better solution for critical space applications to reduce PCB layout demand area like battery-powered equipment, instrumentation, distributed power architectures in communication, industrial electronics, energy facilities and others.

Table of contents

Model Selection Guide	P2	Recommended Pad Layout for Single & Dual Output Converter	P27
Input Specifications	P2	Test Setup	P28
Remote On/Off Control	P2	Technical Notes	P28
Output Specifications	P3	Remote On/Off Implementation	P29
General Specifications	P3	Packaging Information	P29
EMC Specifications	P3	Wave Soldering Considerations	P30
Environmental Specifications	P3	Hand Welding Parameter	P30
Characteristic Curves	P4	Part Number Structure	P31
Package Specifications	P27	MTBF and Reliability	P31

Model Selection Guide

Model Number	Input Voltage (Range)	Output Voltage	Output Current	Input Current		Max. capacitive Load	Efficiency (typ.)
				@Max. Load	@No Load		
	VDC	VDC	mA	mA(typ.)	mA(typ.)	μF	%
MIW10-12S033	12 (9 ~ 18)	3.3	2700	863	20	1000	86
MIW10-12S05		5	2000	980			85
MIW10-12S051		5.1	2000	1000			85
MIW10-12S12		12	833	947			88
MIW10-12S15		15	666	935			89
MIW10-12D12		±12	±416	945			88
MIW10-12D15		±15	±333	935			89
MIW10-24S033	24 (18 ~ 36)	3.3	2700	432	15	1000	86
MIW10-24S05		5	2000	490			85
MIW10-24S051		5.1	2000	500			85
MIW10-24S12		12	833	468			89
MIW10-24S15		15	666	468			89
MIW10-24D12		±12	±416	473			88
MIW10-24D15		±15	±333	468			89
MIW10-48S033	48 (36 ~ 75)	3.3	2700	216	10	1000	86
MIW10-48S05		5	2000	245			85
MIW10-48S051		5.1	2000	250			85
MIW10-48S12		12	833	239			87
MIW10-48S15		15	666	237			88
MIW10-48D12		±12	±416	244			87
MIW10-48D15		±15	±333	237			88

For each output

Input Specifications

Parameter	Model	Min.	Typ.	Max.	Unit
Input Surge Voltage (1 sec. max.)	12V Input Models	-0.7	---	25	VDC
	24V Input Models	-0.7	---	50	
	48V Input Models	-0.7	---	100	
Start-Up Threshold Voltage	12V Input Models	---	---	9	
	24V Input Models	---	---	18	
	48V Input Models	---	---	36	
Under Voltage Shutdown	12V Input Models	---	---	8.5	
	24V Input Models	---	---	17	
	48V Input Models	---	---	34	
Input Filter	All Models	Internal Pi Type			

Remote On/Off Control

Parameter	Conditions	Min.	Typ.	Max.	Unit
Converter On	3.5V ~ 12V or Open Circuit				
Converter Off	0~1.2V or Short Circuit (Pin 1 and Pin 2)				
Control Input Current (on)	Vctrl = 5V	---	---	500	μA
Control Input Current (off)	Vctrl = 0V	---	---	-500	μA
Control Common	Referenced to Negative Input				
Standby Input Current	Nominal Vin	---	---	10	mA

Output Specifications						
Parameter	Conditions	Min.	Typ.	Max.	Unit	
Output Voltage Setting Accuracy		---	±1	±2	%Vnom.	
Output Voltage Balance	Dual Output, Balanced Loads	---	±1	±2.0	%	
Line Regulation	Vin=Min. to Max. @Full Load	---	±0.5	±1.0	%	
Load Regulation	Io=0% to 100%	---	±0.5	±1.2	%	
Minimum Load	No minimum Load Requirement					
Ripple & Noise	0-20 MHz Bandwidth	3.3 & 5V Output	---	80	---	mV _{P-P}
		Other Output	---	100	---	mV _{P-P}
Transient Recovery Time	25% Load Step Change	---	300	600	µsec	
Transient Response Deviation		---	±3	±5	%	
Temperature Coefficient		---	±0.01	±0.02	%/°C	
Over Load Protection	Hiccup	110	150	---	%	
Short Circuit Protection	Continuous, Automatic Recovery (Hiccup Mode 0.7Hz typ.)					

General Specifications					
Parameter	Conditions	Min.	Typ.	Max.	Unit
I/O Isolation Voltage	60 Seconds	1500	---	---	VDC
	1 Second	1800	---	---	VDC
I/O Isolation Resistance	500 VDC	1000	---	---	MΩ
I/O Isolation Capacitance	100kHz, 1V	---	1000	1500	pF
Switching Frequency		---	330	---	kHz
MTBF (calculated)	MIL-HDBK-217F@25°C, Ground Benign	1,000,000	---	---	Hours
Safety Approvals	UL/cUL 60950-1 recognition (CSA certificate), IEC/EN 60950-1 (CB-report)				
	UL/cUL 62368-1 recognition (UL certificate), IEC/EN 62368-1 (CB-report)				

EMC Specifications			
Parameter	Standards & Level		Performance
EMI ₍₅₎	Conduction	EN 55022	Without external components
	Radiation		With external components
EMS ₍₅₎	EN 55024		
	ESD	EN 61000-4-2 Air ± 8kV , Contact ± 6kV	A
	Radiated immunity	EN 61000-4-3 10V/m	A
	Fast transient	EN 61000-4-4 ±2kV	A
	Surge	EN 61000-4-5 ±1kV	A
	Conducted immunity	EN 61000-4-6 10Vrms	A

Environmental Specifications			
Parameter	Min.	Max.	Unit
Operating Ambient Temperature Range (See Power Derating Curve)	-40	+85	°C
Case Temperature	---	+105	°C
Storage Temperature Range	-50	+125	°C
Humidity (non condensing)	---	95	% rel. H
Lead Temperature (1.5mm from case for 10Sec.)	---	260	°C

Notes	
1	Specifications typical at Ta=+25°C, resistive load, nominal input voltage and rated output current unless otherwise noted.
2	Transient recovery time is measured to within 1% error band for a step change in output load of 75% to 100%.
3	We recommend to protect the converter by a fast blow fuse in the input supply line.
4	Other input and output voltages may be available, please contact MINMAX.
5	The external components might be required to meet EMI/EMS standard for some of test items. Please contact MINMAX for the solution in detail.
6	Specifications are subject to change without notice.

Characteristic Curves

All test conditions are at 25°C The figures are identical for MIW10-12S033

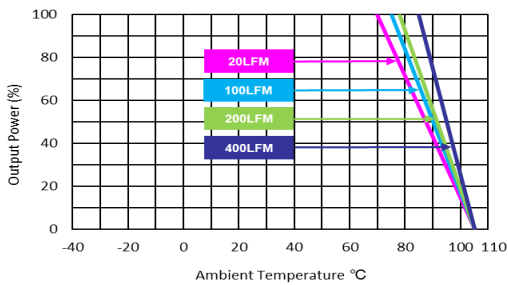
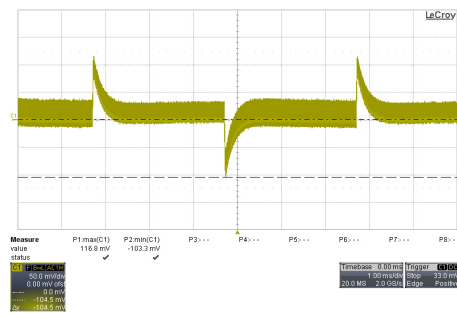
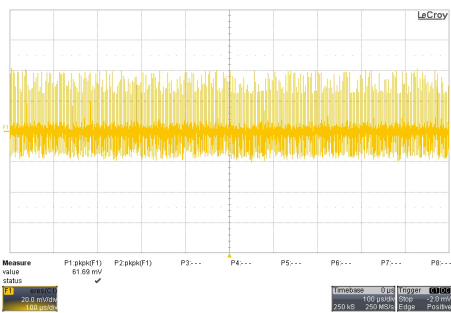
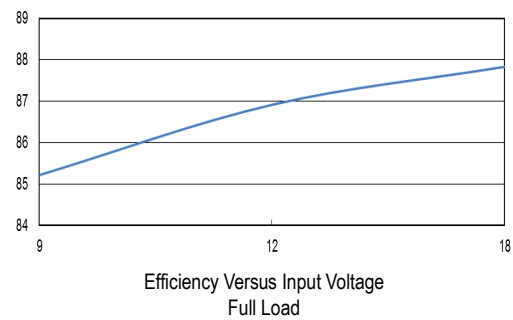
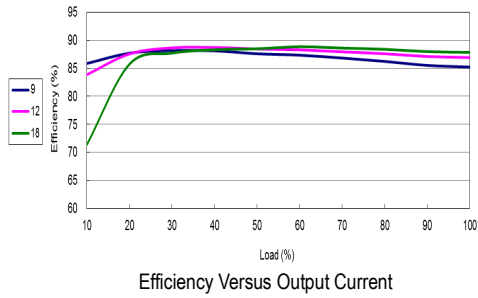

Characteristic Curves

All test conditions are at 25°C The figures are identical for MIW10-12S05

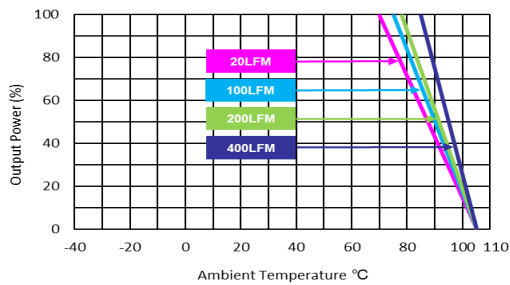
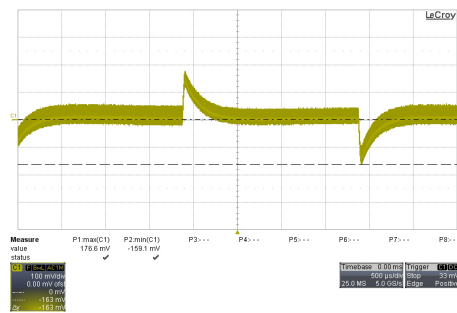
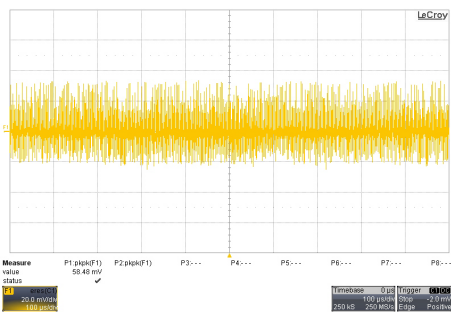
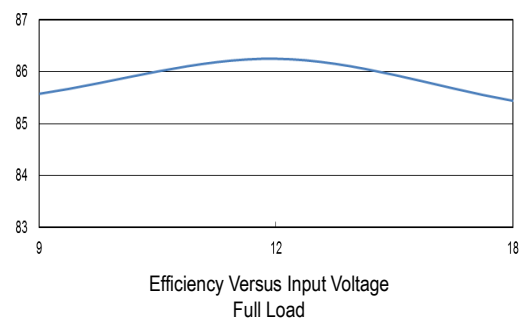
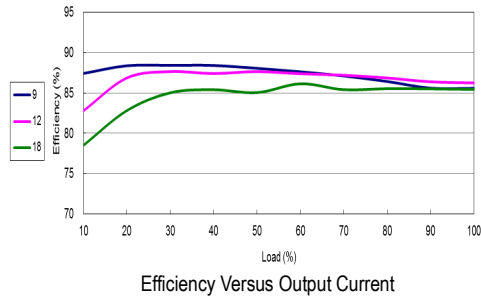

Characteristic Curves

All test conditions are at 25°C The figures are identical for MIW10-12S033

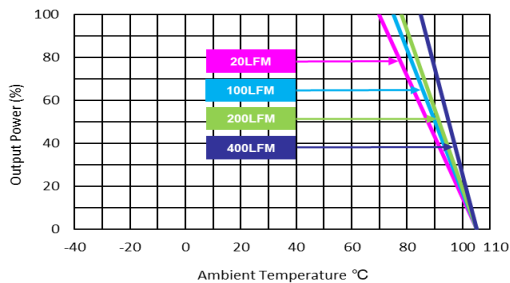
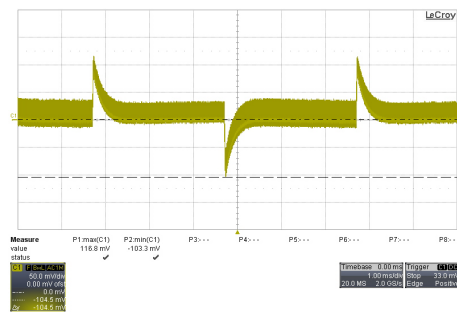
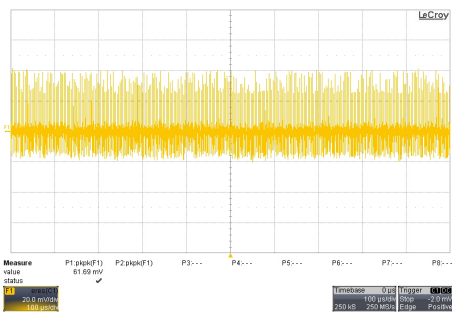
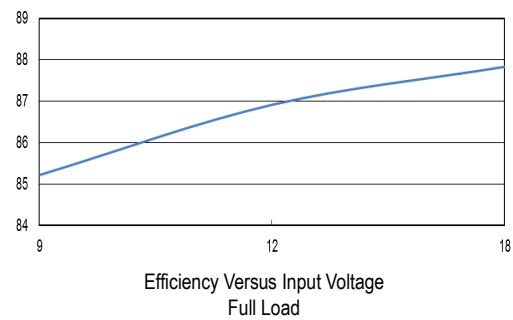
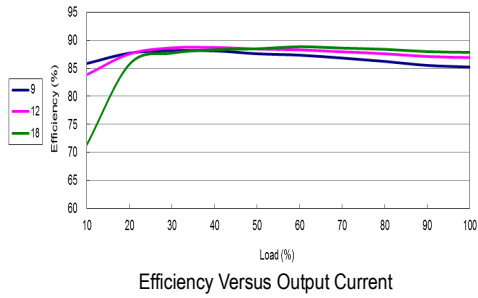

Characteristic Curves

All test conditions are at 25°C The figures are identical for MIW10-12S05

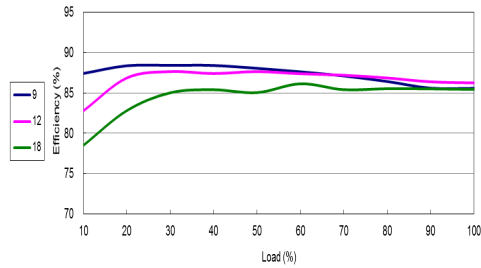

Efficiency Versus Output Current

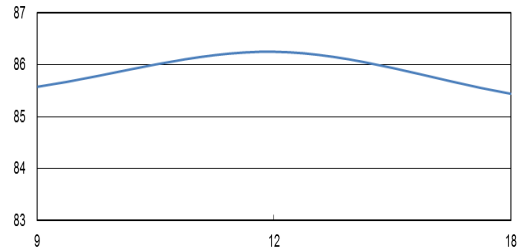

Efficiency Versus Input Voltage Full Load

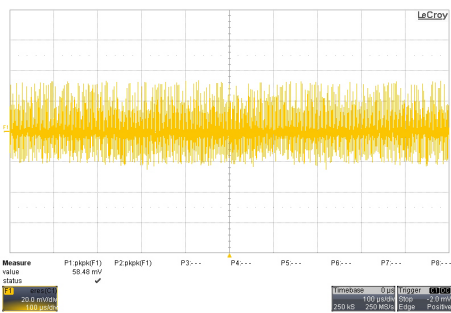

Typical Output Ripple and Noise
 $V_{in}=V_{in\ nom}$; Full Load

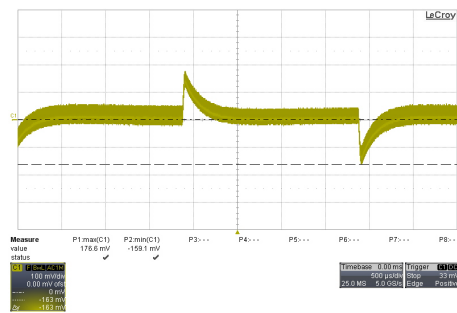

Transient Response to Dynamic Load Change
from 100% to 75% of Full Load ; $V_{in}=V_{in\ nom}$

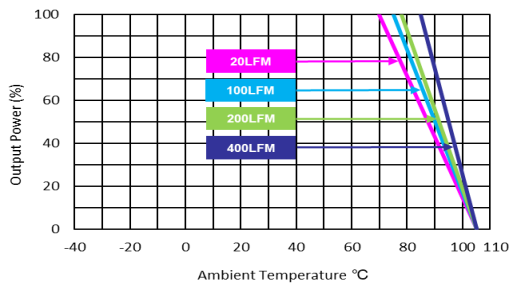

Derating Output Power Versus Ambient Temperature
 $V_{in}=V_{in\ nom}$

Characteristic Curves

All test conditions are at 25°C The figures are identical for MIW10-12S051

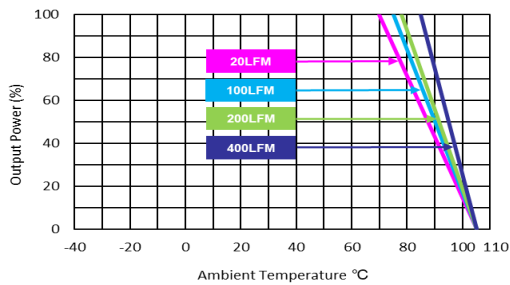
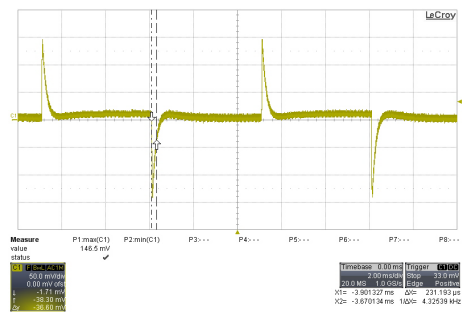
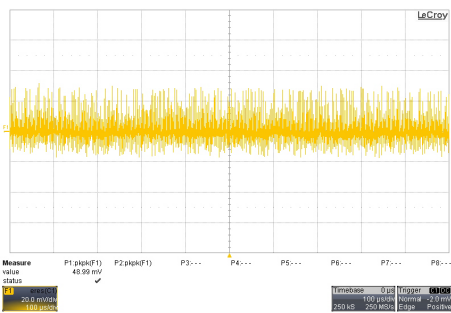
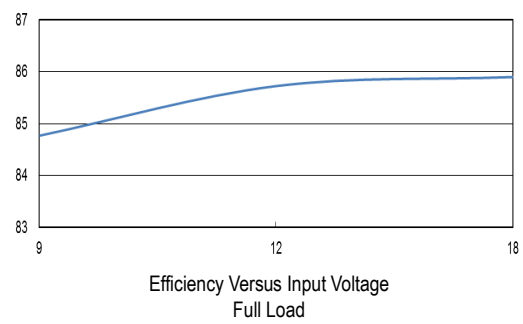
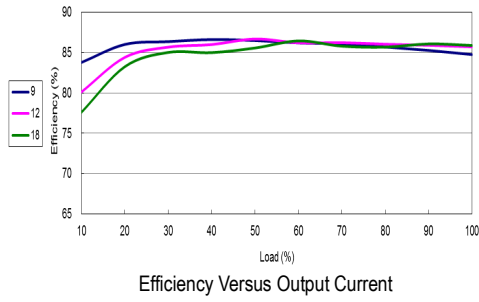

Characteristic Curves

All test conditions are at 25°C The figures are identical for MIW10-12S12

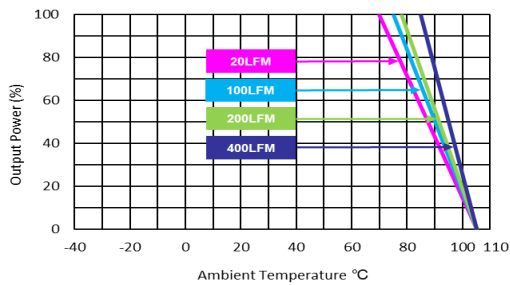
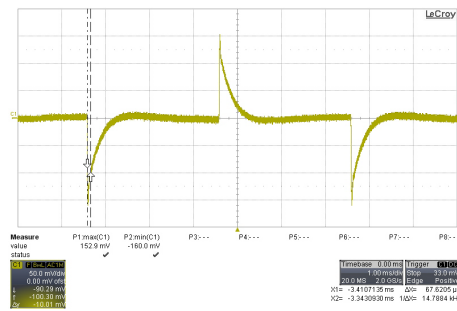
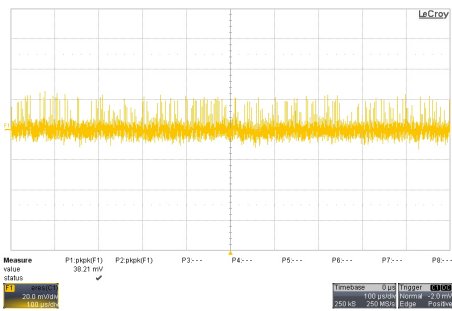
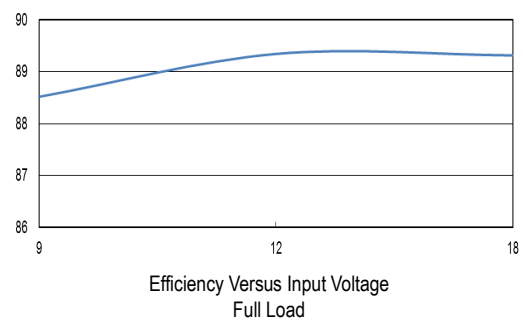
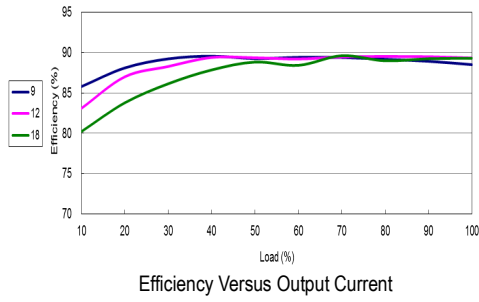

Characteristic Curves

All test conditions are at 25°C The figures are identical for MIW10-12S15

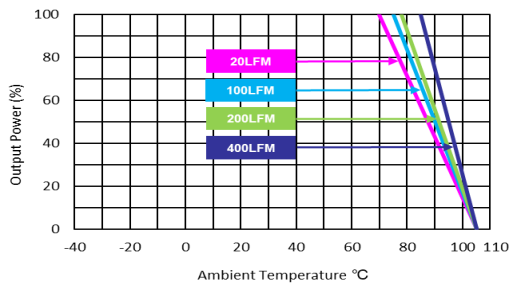
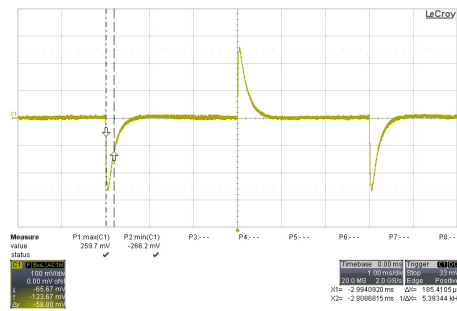
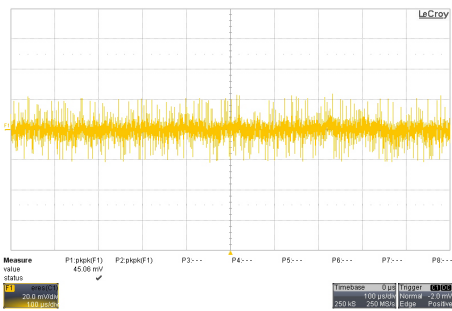
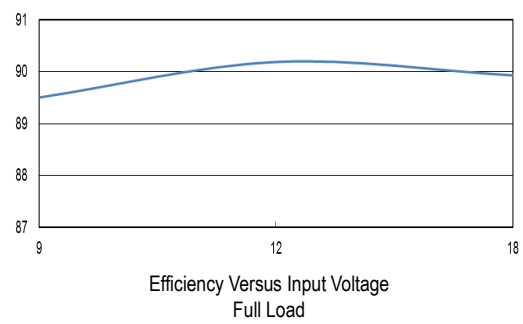
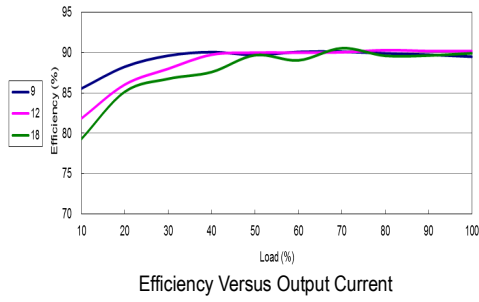

Characteristic Curves

All test conditions are at 25°C The figures are identical for MIW10-12D12

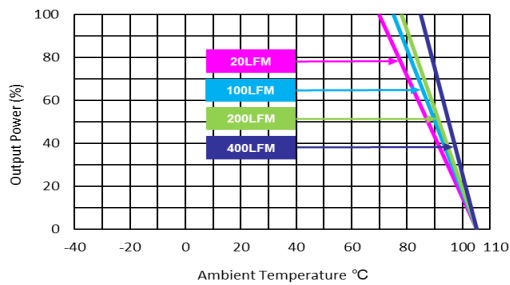
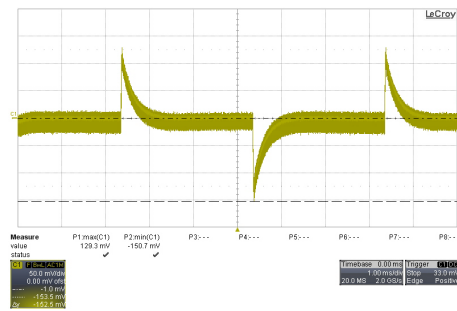
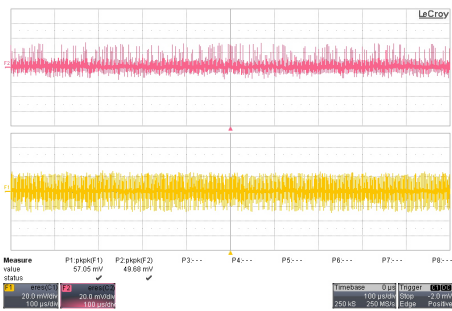
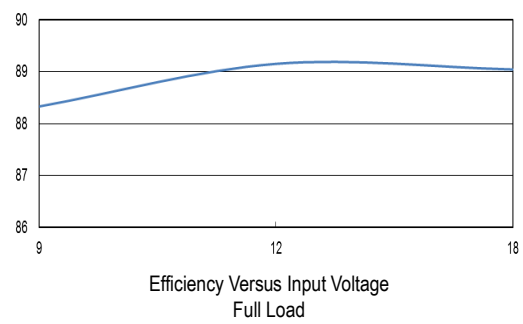
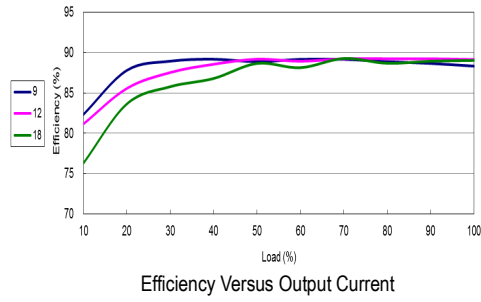

Characteristic Curves

All test conditions are at 25°C The figures are identical for MIW10-12D15

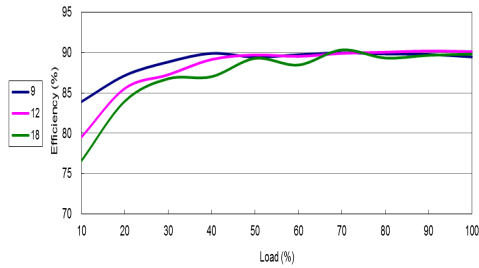

Efficiency Versus Output Current

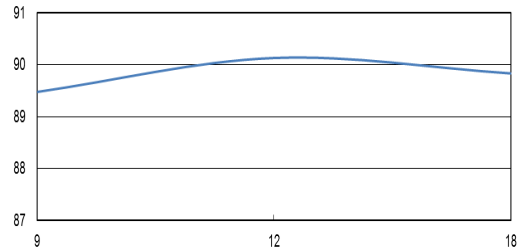

Efficiency Versus Input Voltage Full Load

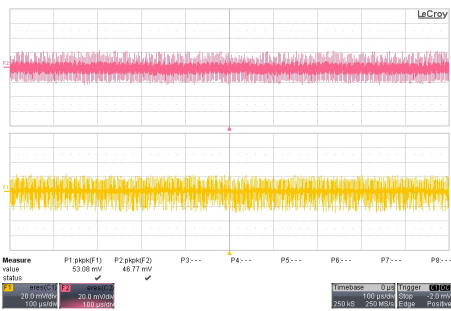

Typical Output Ripple and Noise
 $V_{in}=V_{in\ nom}$; Full Load

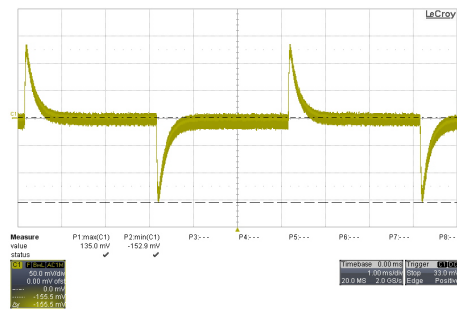

Transient Response to Dynamic Load Change
from 100% to 75% of Full Load ; $V_{in}=V_{in\ nom}$

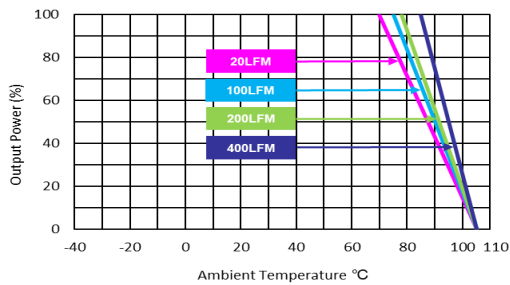

Derating Output Power Versus Ambient Temperature
 $V_{in}=V_{in\ nom}$

Characteristic Curves

All test conditions are at 25°C The figures are identical for MIW10-24S033

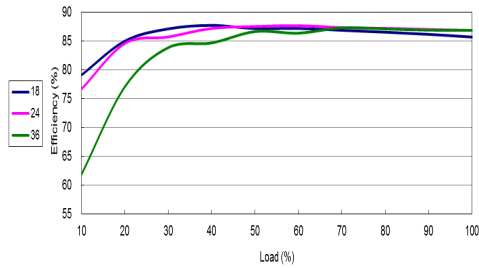

Efficiency Versus Output Current

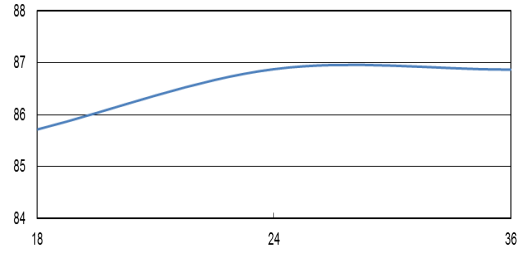

Efficiency Versus Input Voltage Full Load

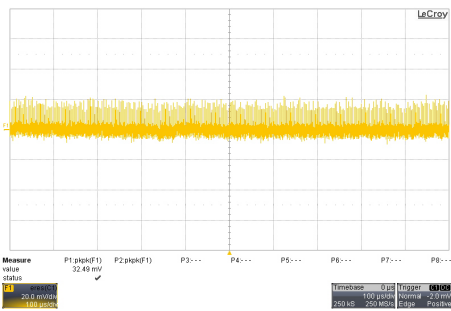

Typical Output Ripple and Noise
 $V_{in}=V_{in\ nom}$; Full Load

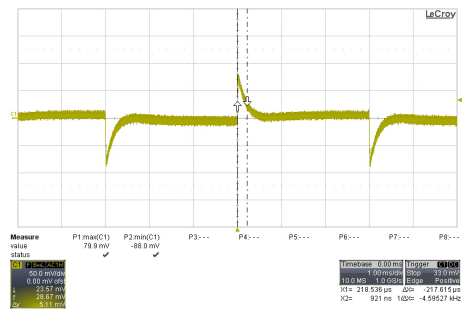

Transient Response to Dynamic Load Change
from 100% to 75% of Full Load ; $V_{in}=V_{in\ nom}$

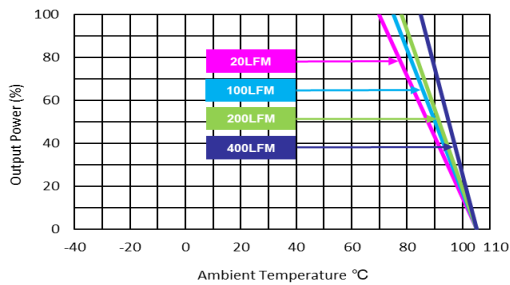

Derating Output Power Versus Ambient Temperature
 $V_{in}=V_{in\ nom}$

Characteristic Curves

All test conditions are at 25°C The figures are identical for MIW10-24S05

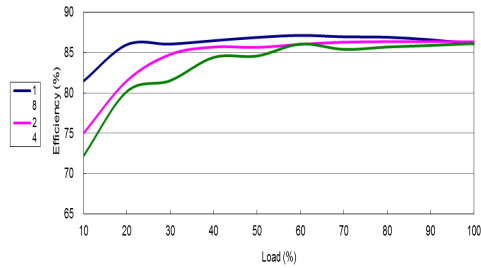

Efficiency Versus Output Current

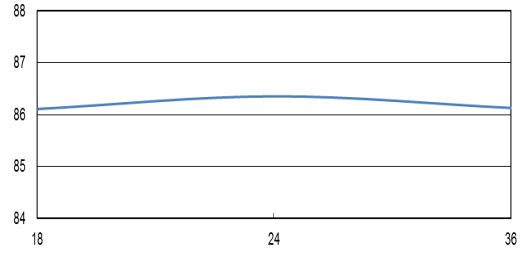

Efficiency Versus Input Voltage Full Load

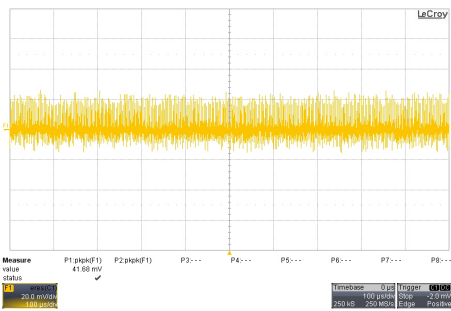

Typical Output Ripple and Noise
 $V_{in}=V_{in\ nom}$; Full Load

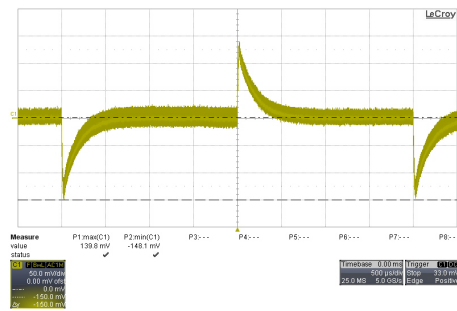

Transient Response to Dynamic Load Change
from 100% to 75% of Full Load ; $V_{in}=V_{in\ nom}$

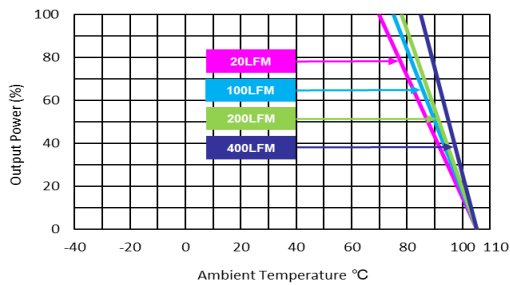

Derating Output Power Versus Ambient Temperature
 $V_{in}=V_{in\ nom}$

Characteristic Curves

All test conditions are at 25°C The figures are identical for MIW10-24S051

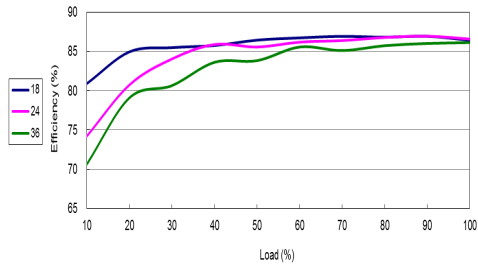

Efficiency Versus Output Current

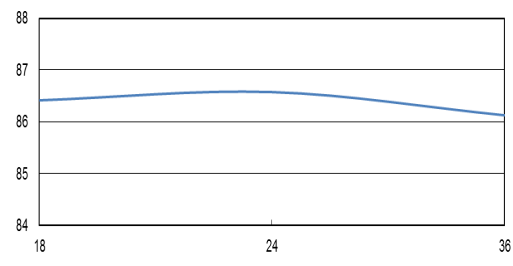

Efficiency Versus Input Voltage Full Load

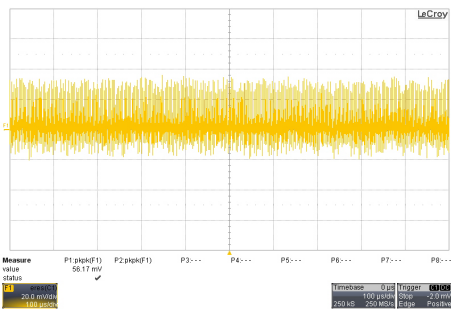

Typical Output Ripple and Noise
 $V_{in}=V_{in\ nom}$; Full Load

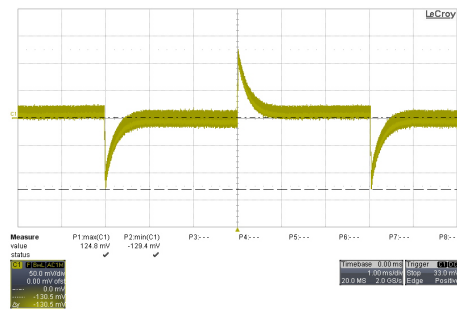

Transient Response to Dynamic Load Change
from 100% to 75% of Full Load ; $V_{in}=V_{in\ nom}$

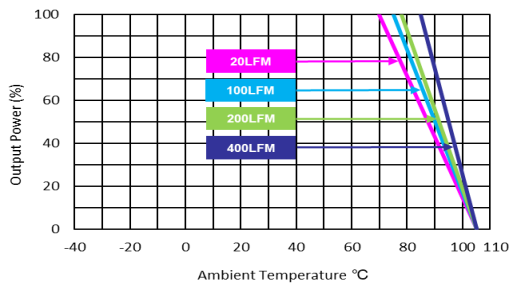

Derating Output Power Versus Ambient Temperature
 $V_{in}=V_{in\ nom}$

Characteristic Curves

All test conditions are at 25°C The figures are identical for MIW10-24S12

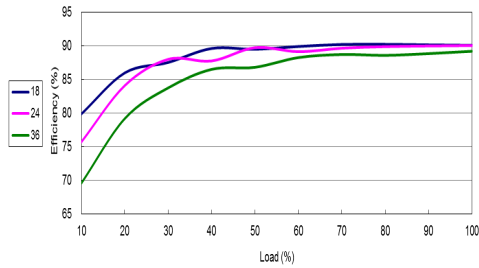

Efficiency Versus Output Current

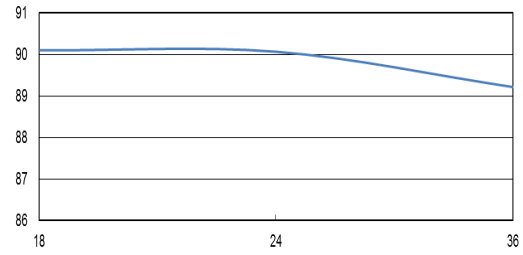

Efficiency Versus Input Voltage Full Load

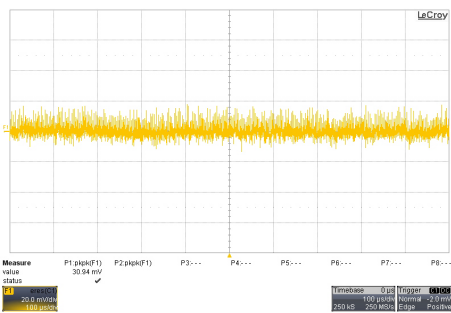

Typical Output Ripple and Noise
 $V_{in}=V_{in\ nom}$; Full Load

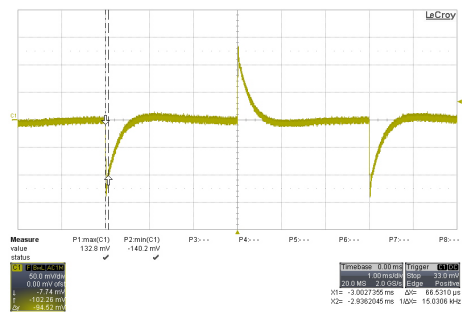

Transient Response to Dynamic Load Change
from 100% to 75% of Full Load ; $V_{in}=V_{in\ nom}$

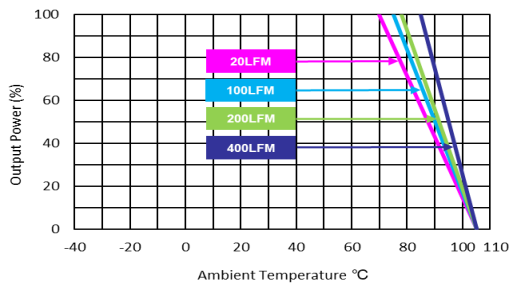

Derating Output Power Versus Ambient Temperature
 $V_{in}=V_{in\ nom}$

Characteristic Curves

All test conditions are at 25°C The figures are identical for MIW10-24S15

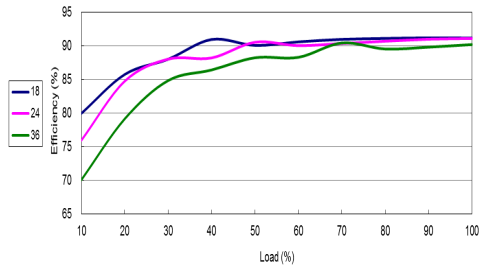

Efficiency Versus Output Current

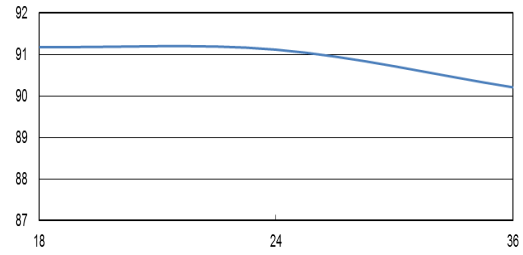

Efficiency Versus Input Voltage Full Load

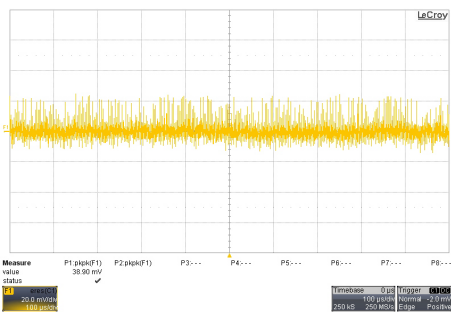

Typical Output Ripple and Noise
 $V_{in}=V_{in\ nom}$; Full Load

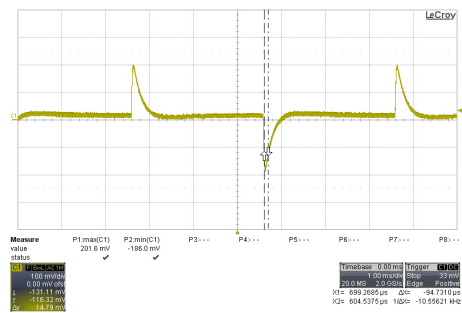

Transient Response to Dynamic Load Change
from 100% to 75% of Full Load ; $V_{in}=V_{in\ nom}$

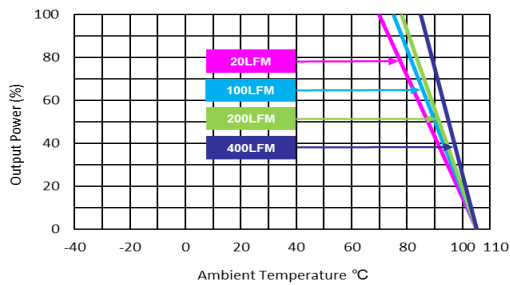

Derating Output Power Versus Ambient Temperature
 $V_{in}=V_{in\ nom}$

Characteristic Curves

All test conditions are at 25°C The figures are identical for MIW10-24D12

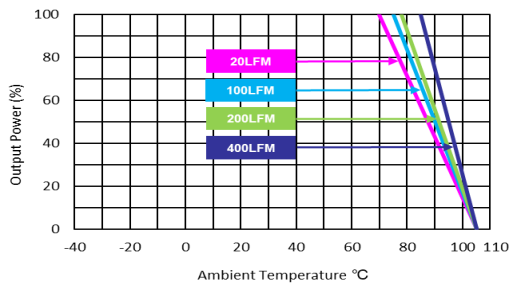
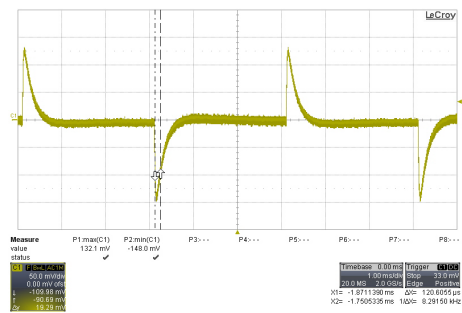
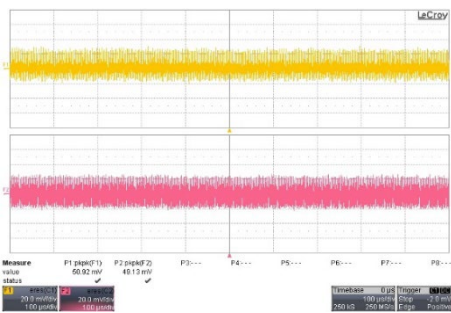
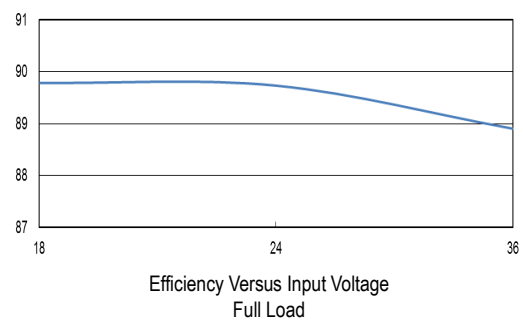
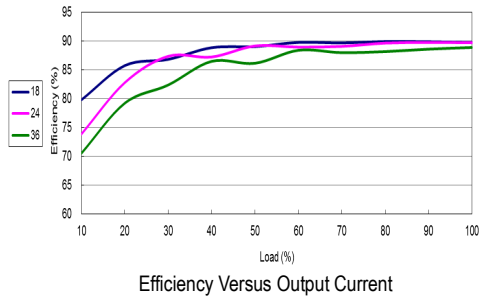

Characteristic Curves

All test conditions are at 25°C The figures are identical for MIW10-24D15

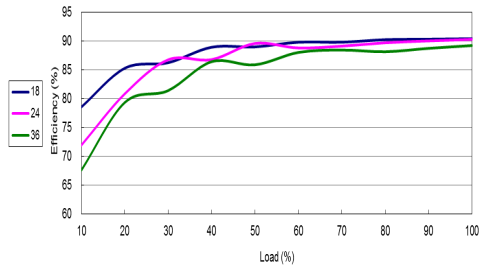

Efficiency Versus Output Current

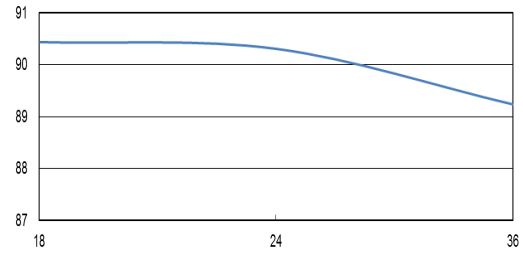

Efficiency Versus Input Voltage Full Load

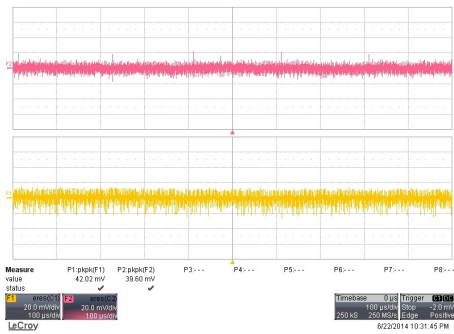

Typical Output Ripple and Noise
 $V_{in}=V_{in\ nom}$; Full Load

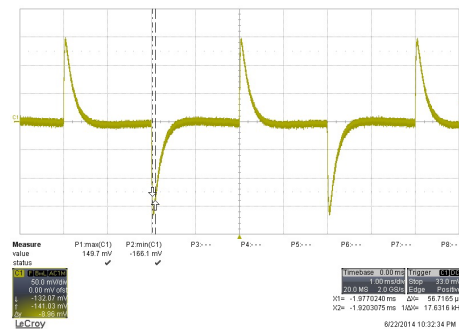

Transient Response to Dynamic Load Change
from 100% to 75% of Full Load ; $V_{in}=V_{in\ nom}$

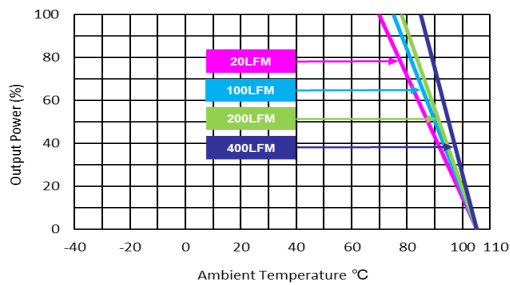

Derating Output Power Versus Ambient Temperature
 $V_{in}=V_{in\ nom}$

Characteristic Curves

All test conditions are at 25°C The figures are identical for MIW10-48S033

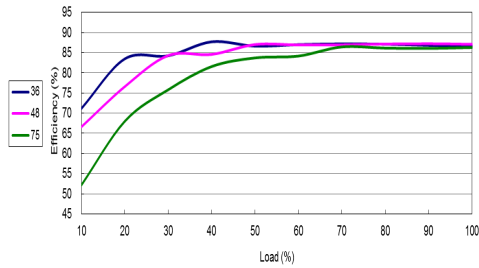

Efficiency Versus Output Current

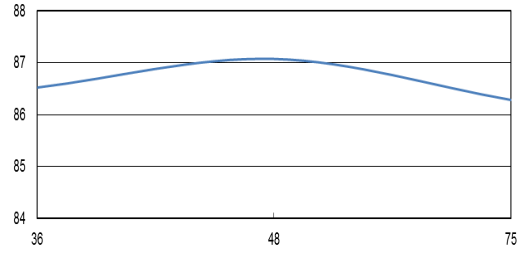

Efficiency Versus Input Voltage Full Load

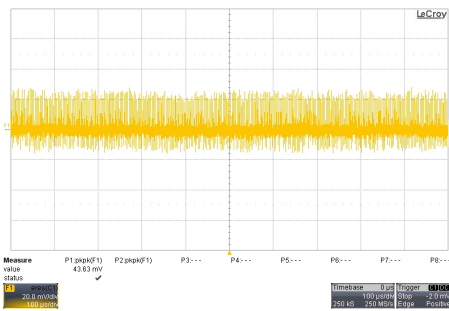

Typical Output Ripple and Noise
 $V_{in}=V_{in\ nom}$; Full Load

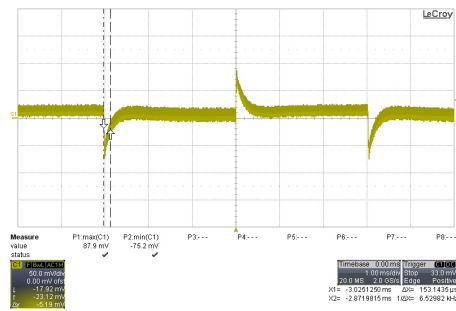

Transient Response to Dynamic Load Change
from 100% to 75% of Full Load ; $V_{in}=V_{in\ nom}$

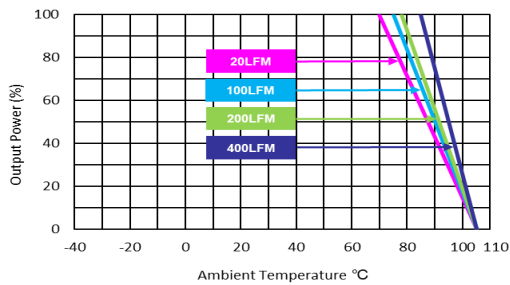

Derating Output Power Versus Ambient Temperature
 $V_{in}=V_{in\ nom}$

Characteristic Curves

All test conditions are at 25°C The figures are identical for MIW10-48S05

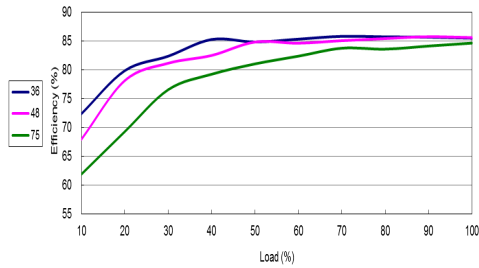

Efficiency Versus Output Current

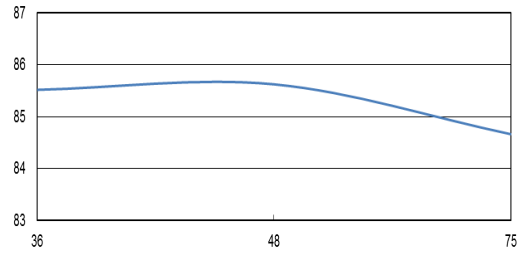

Efficiency Versus Input Voltage Full Load

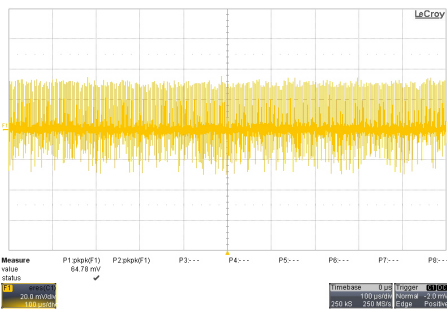

Typical Output Ripple and Noise
 $V_{in}=V_{in\ nom}$; Full Load

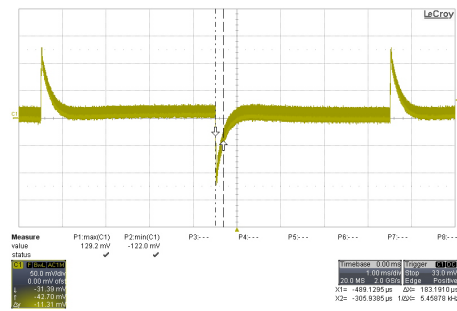

Transient Response to Dynamic Load Change
from 100% to 75% of Full Load ; $V_{in}=V_{in\ nom}$

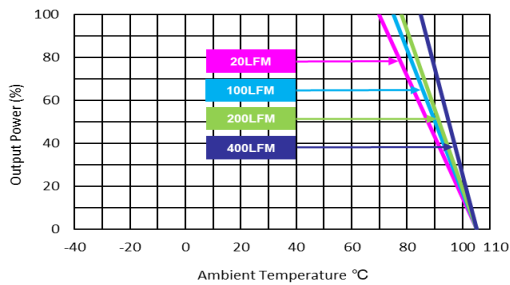

Derating Output Power Versus Ambient Temperature
 $V_{in}=V_{in\ nom}$

Characteristic Curves

All test conditions are at 25°C The figures are identical for MIW10-48S051

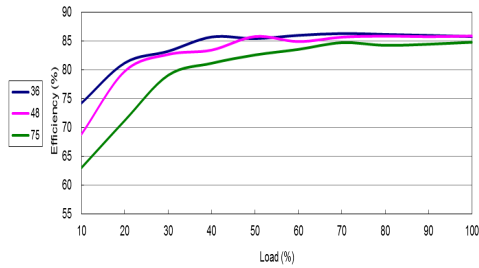

Efficiency Versus Output Current

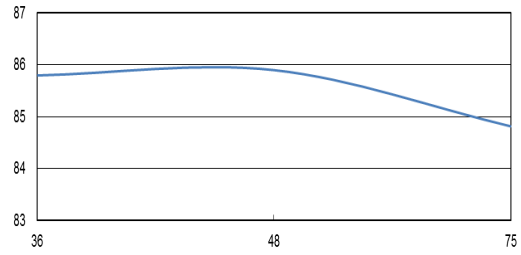

Efficiency Versus Input Voltage Full Load

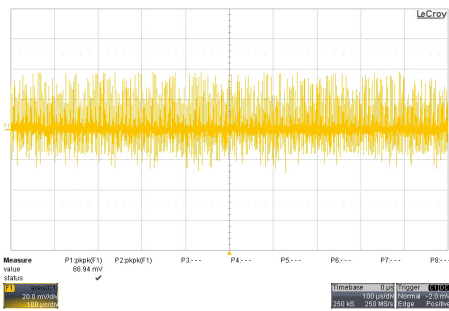

Typical Output Ripple and Noise
 $V_{in}=V_{in\ nom}$; Full Load

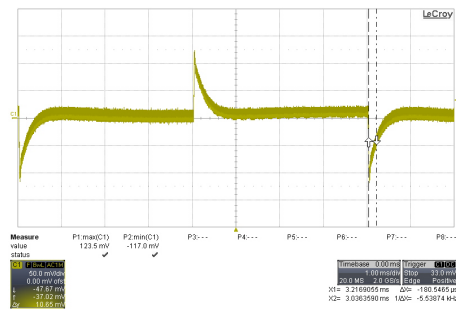

Transient Response to Dynamic Load Change
from 100% to 75% of Full Load ; $V_{in}=V_{in\ nom}$

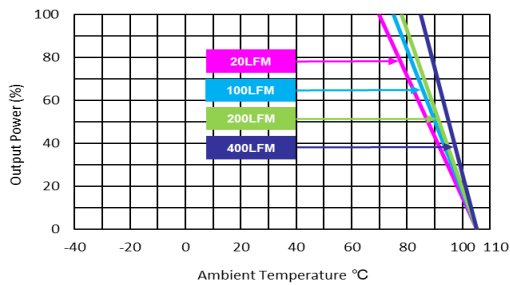

Derating Output Power Versus Ambient Temperature
 $V_{in}=V_{in\ nom}$

Characteristic Curves

All test conditions are at 25°C The figures are identical for MIW10-48S12

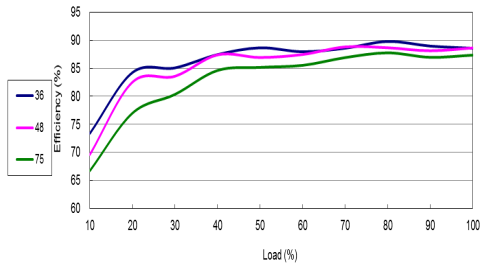

Efficiency Versus Output Current

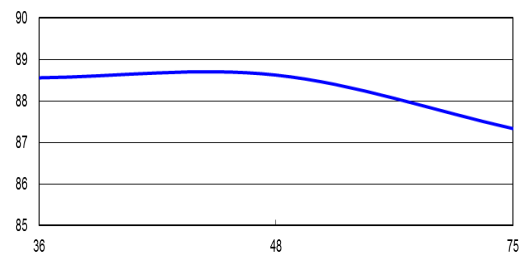

Efficiency Versus Input Voltage Full Load

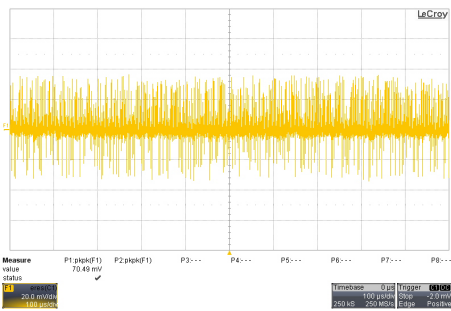

Typical Output Ripple and Noise
 $V_{in}=V_{in\ nom}$; Full Load

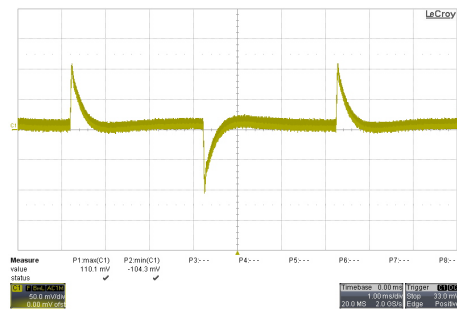

Transient Response to Dynamic Load Change
from 100% to 75% of Full Load ; $V_{in}=V_{in\ nom}$

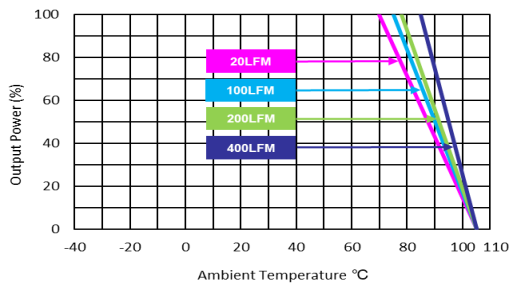

Derating Output Power Versus Ambient Temperature
 $V_{in}=V_{in\ nom}$

Characteristic Curves

All test conditions are at 25°C The figures are identical for MIW10-48S15

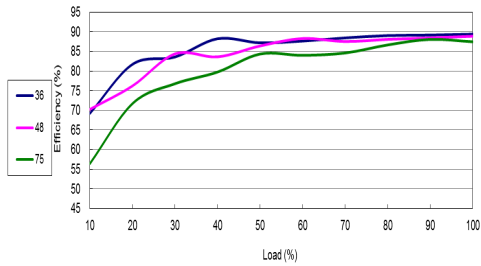

Efficiency Versus Output Current

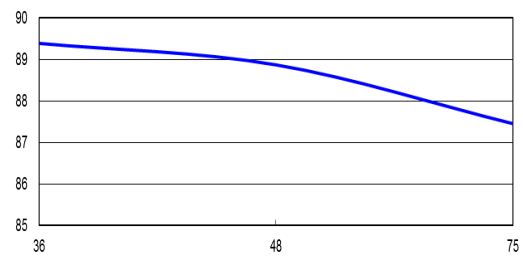

Efficiency Versus Input Voltage Full Load

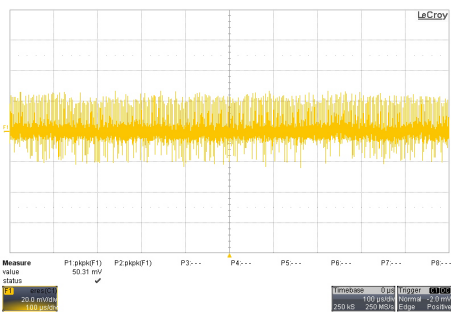

Typical Output Ripple and Noise
 $V_{in}=V_{in\ nom}$; Full Load

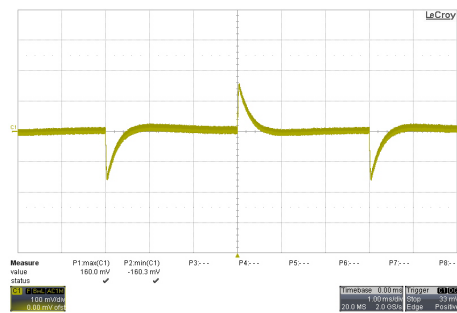

Transient Response to Dynamic Load Change
from 100% to 75% of Full Load ; $V_{in}=V_{in\ nom}$

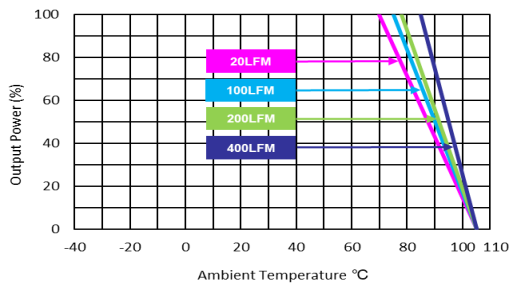

Derating Output Power Versus Ambient Temperature
 $V_{in}=V_{in\ nom}$

Characteristic Curves

All test conditions are at 25°C The figures are identical for MIW10-48D12

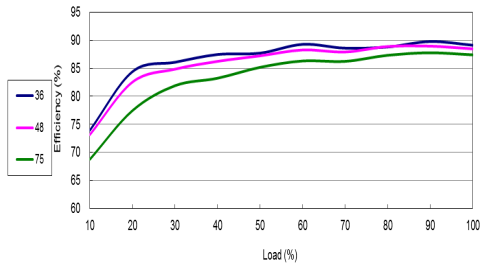

Efficiency Versus Output Current

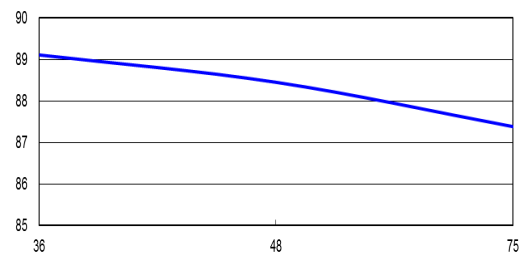

Efficiency Versus Input Voltage Full Load

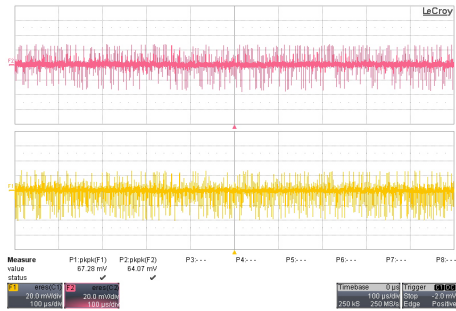

Typical Output Ripple and Noise
 $V_{in}=V_{in\ nom}$; Full Load

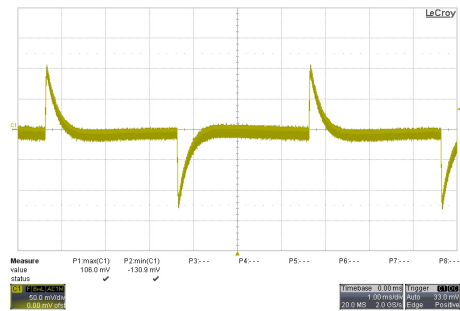

Transient Response to Dynamic Load Change
from 100% to 75% of Full Load ; $V_{in}=V_{in\ nom}$

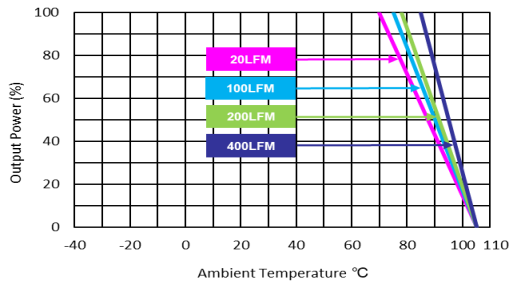

Derating Output Power Versus Ambient Temperature
 $V_{in}=V_{in\ nom}$

Characteristic Curves

All test conditions are at 25°C The figures are identical for MIW10-48D15

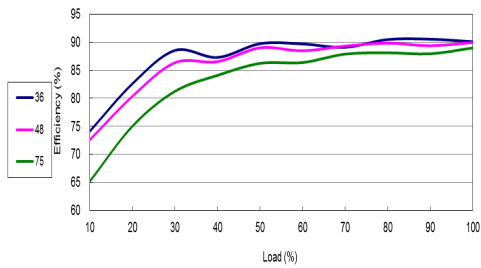

Efficiency Versus Output Current

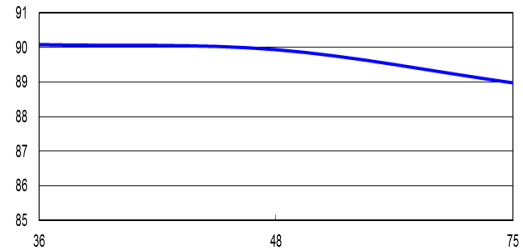

Efficiency Versus Input Voltage Full Load

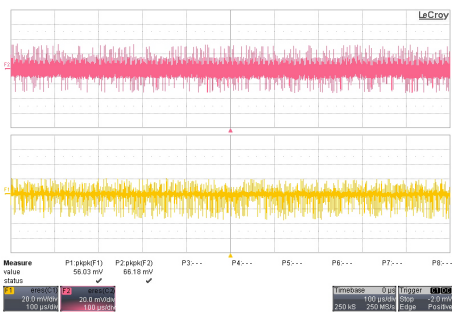

Typical Output Ripple and Noise
 $V_{in}=V_{in\ nom}$; Full Load

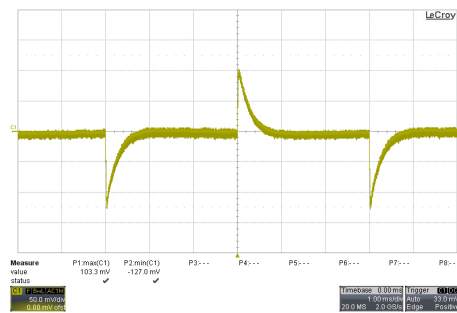

Transient Response to Dynamic Load Change
from 100% to 75% of Full Load ; $V_{in}=V_{in\ nom}$

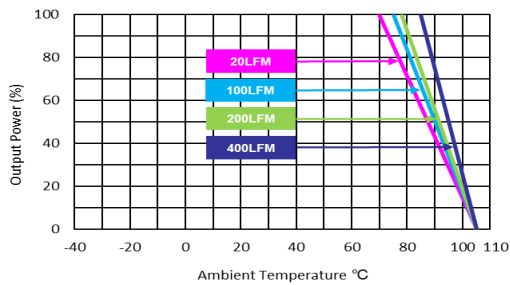

Derating Output Power Versus Ambient Temperature
 $V_{in}=V_{in\ nom}$

Test Setup

Peak-to-Peak Output Noise Measurement Test

Use a C_{out} 0.47 μ F ceramic capacitor. Scope measurement should be made by using a BNC socket, measurement bandwidth is 0-20 MHz. Position the load between 50 mm and 75 mm from the DC-DC Converter.

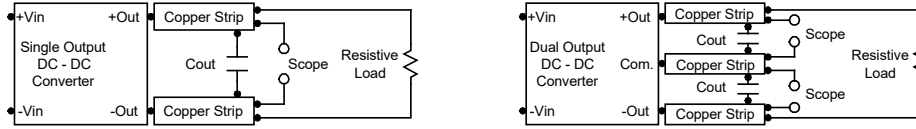

Technical Notes

Remote On/Off

Positive logic remote on/off turns the module on during a logic high voltage on the remote on/off pin, and off during a logic low. To turn the power module on and off, the user must supply a switch to control the voltage between the on/off terminal and the -Vin terminal. The switch can be an open collector or equivalent. A logic low is 0V to 1.2V. A logic high is 3.5V to 12V. The maximum sink current at the on/off terminal (Pin 1) during a logic low is -100 μ A.

Overload Protection

To provide protection in a fault (output overload) condition, the unit is equipped with internal current limiting circuitry and can endure current limiting for an unlimited duration. At the point of current-limit inception, the unit shifts from voltage control to current control. The unit operates normally once the output current is brought back into its specified range.

Overvoltage Protection

The output overvoltage clamp consists of control circuitry, which is independent of the primary regulation loop, that monitors the voltage on the output terminals. The control loop of the clamp has a higher voltage set point than the primary loop. This provides a redundant voltage control that reduces the risk of output overvoltage.

Input Source Impedance

The power module should be connected to a low ac-impedance input source. Highly inductive source impedances can affect the stability of the power module. In applications where power is supplied over long lines and output loading is high, it may be necessary to use a capacitor at the input to ensure startup. By using a good quality low Equivalent Series Resistance (ESR < 1.0 Ω at 100 kHz) capacitor of a 12 μ F for the 12V, 4.7 μ F for the 24V input devices and a 2.2 μ F for the 48V devices, capacitor mounted close to the power module helps ensure stability of the unit.

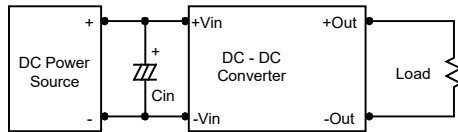

Output Ripple Reduction

A good quality low ESR capacitor placed as close as practicable across the load will give the best ripple and noise performance. To reduce output ripple, it is recommended to use 3.3 μ F capacitors at the output.

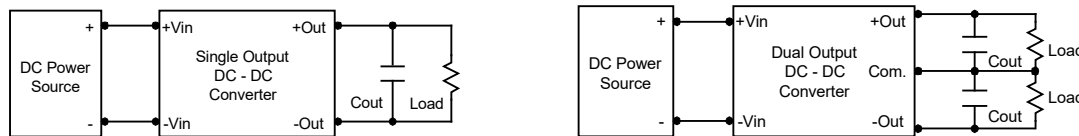

Maximum Capacitive Load

The MIW10 series has limitation of maximum connected capacitance on the output. The power module may operate in current limiting mode during start-up, affecting the ramp-up and the startup time. The maximum capacitance can be found in the data sheet.

Thermal Considerations

Many conditions affect the thermal performance of the power module, such as orientation, airflow over the module and board spacing. To avoid exceeding the maximum temperature rating of the components inside the power module, the case temperature must be kept below 105°C. The derating curves are determined from measurements obtained in a test setup.

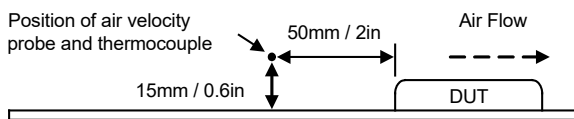

Remote On/Off Implementation

The positive logic remote ON/OFF control circuit is included. Turns the module ON during logic High on the ON/Off pin and turns OFF during logic Low. The ON/OFF input signal ($V_{on/off}$) that referenced to GND. If not using the remote on/off feature, please open circuit between on/off pin and -Vin pin to turn the module on.

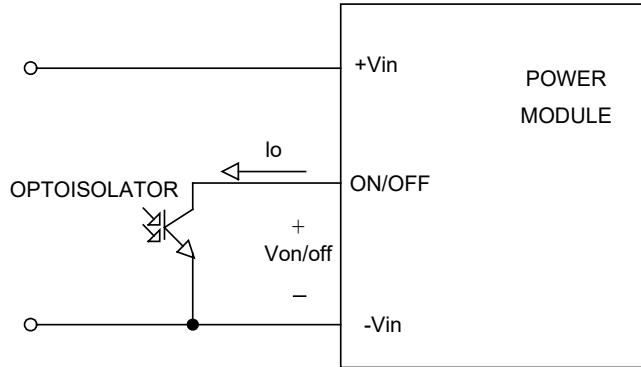

Isolated-Closure Remote ON/OFF

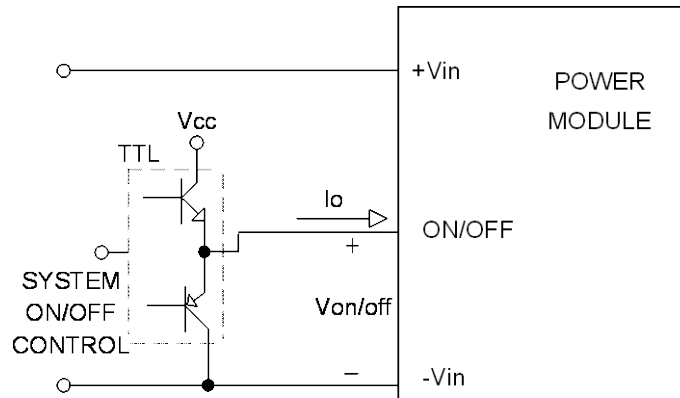

Level Control Using TTL Output

Packaging Information

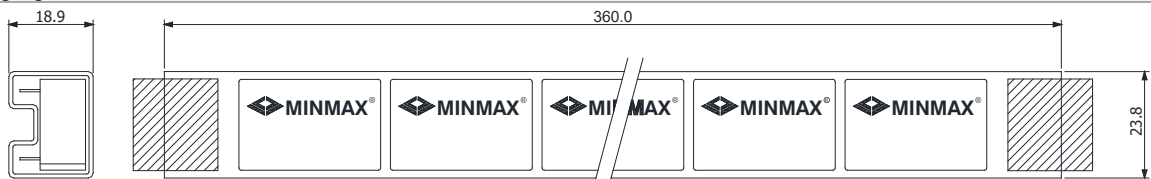

Unit: mm
10 PCS per TUBE

Wave Soldering Considerations

Lead free wave solder profile

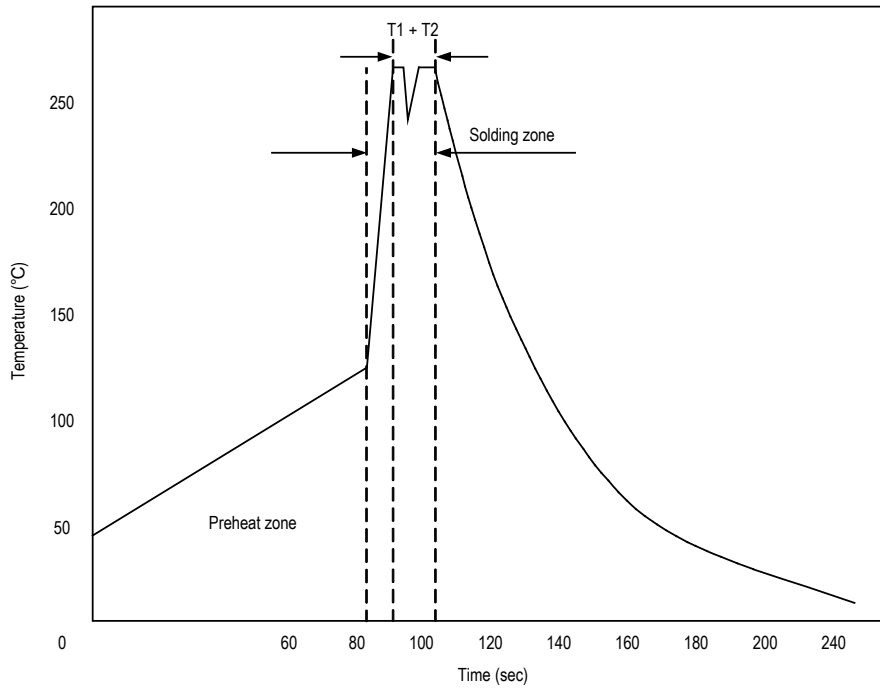

Zone	Reference Parameter
Preheat	Rise temp. speed : 3°C/sec max.
zone	Preheat temp. : 100~130°C
Actual	Peak temp. : 250~260°C
heating	Peak time(T1+T2) : 4~6 sec

Hand Welding Parameter

Reference Solder: Sn-Ag-Cu : Sn-Cu : Sn-Ag

Hand Welding: Soldering iron : Power 60W

Welding Time: 2~4 sec

Temp.: 380~400°C

Part Number Structure							
M	I	W	10	-	12	S	033
	Package Type DIP-24	Wide 2:1 Input Voltage Range	Output Power 10 Watt		Input Voltage Range 12: 9 ~ 18 VDC 24: 18 ~ 36 VDC 48: 36 ~ 75 VDC	Output Quantity S: Single D: Dual	Output Voltage 033: 3.3 VDC 05: 5 VDC 051: 5.1 VDC 12: 12 VDC 15: 15 VDC

MTBF and Reliability

The MTBF of MIW10 series of DC-DC converters has been calculated using

MIL-HDBK 217F NOTICE2, Operating Temperature 25°C, Ground Benign.

Model	MTBF	Unit
MIW10-12S033	785,200	Hours
MIW10-12S05	1,132,630	
MIW10-12S051	1,132,630	
MIW10-12S12	1,143,981	
MIW10-12S15	1,214,603	
MIW10-12D12	1,143,853	
MIW10-12D15	1,214,459	
MIW10-24S033	785,200	
MIW10-24S05	924,207	
MIW10-24S051	924,207	
MIW10-24S12	929,739	
MIW10-24S15	976,099	
MIW10-24D12	926,913	
MIW10-24D15	996,392	
MIW10-48S033	848,755	
MIW10-48S05	1,024,788	
MIW10-48S051	1,024,788	
MIW10-48S12	941,879	
MIW10-48S15	1,014,746	
MIW10-48D12	942,358	
MIW10-48D15	1,015,276	