



MINMAX[®]

MIWI10 Series

Electric Characteristic Note

MIWI10 Series EC Note

DC-DC CONVERTER 10W, DIP-Package

Features

- ▶ Industrial Standard DIP-24 Package
- ▶ Ultra-wide 4:1 Input Voltage Range
- ▶ Fully Regulated Output Voltage
- ▶ High Efficiency up to 87%
- ▶ I/O Isolation 1500 VDC
- ▶ Operating Temp. Range -40°C to +85°C
- ▶ No Min. Load Requirement
- ▶ Overload and Short Circuit Protection
- ▶ Remote On/Off Control
- ▶ Shielded Metal Case with Insulated Baseplate
- ▶ UL/cUL/IEC/EN 62368-1(60950-1) Safety Approval



Applications

- ▶ Distributed power architectures
- ▶ Workstations
- ▶ Computer equipment
- ▶ Communications equipment

Product Overview

The MINMAX MIWI10 series is a range of cost-optimized 10W DC-DC converter modules with ultra-wide 4:1 input ranges and fixed tightly regulated output voltages. The converters come in a shielded metal package in the standard DIP-24 format. By state-of-the-art circuit topology a high efficiency could be achieved allowing an operating temperature up to +70°C at full load. Further features include remote ON/OFF, under-voltage, overload and short circuit protection. These converters modules will find a wide range of applications like battery operated instrumentation, distributed power architectures in Communication equipment and in industrial electronics.

Table of contents

Model Selection Guide	P2	Recommended Pad Layout for Single & Dual Output Converter	P20
Input Specifications	P2	Test Setup	P21
Remote On/Off Control	P2	Technical Notes	P21
Output Specifications	P2	Remote On/Off Implementation	P22
General Specifications	P3	Packaging Information	P22
EMC Specifications	P3	Wave Soldering Considerations	P23
Environmental Specifications	P3	Hand Welding Parameter	P23
Characteristic Curves	P4	Part Number Structure	P24
Package Specifications	P20	MTBF and Reliability	P24

Model Selection Guide

Model Number	Input Voltage (Range)	Output Voltage	Output Current	Input Current		Reflected Ripple Current	Max. capacitive Load	Efficiency (typ.)
			Max.	@Max. Load	@No Load			@Max. Load
	VDC	VDC	mA	mA(typ.)	mA(typ.)	mA(typ.)	μF	%
MIWI10-24S033	24 (9 ~ 36)	3.3	2700	432	30	40	1000	86
MIWI10-24S05		5	2000	490				85
MIWI10-24S051		5.1	2000	500				85
MIWI10-24S12		12	833	479				87
MIWI10-24S15		15	666	478				87
MIWI10-24S24		24	416	478				87
MIWI10-24D12		±12	±416	478				87
MIWI10-24D15		±15	±333	478				87
MIWI10-48S033	48 (18 ~ 75)	3.3	2700	216	20	30	1000	86
MIWI10-48S05		5	2000	245				85
MIWI10-48S051		5.1	2000	250				85
MIWI10-48S12		12	833	239				87
MIWI10-48S15		15	666	236				87
MIWI10-48S24		24	416	244				87
MIWI10-48D12		±12	±416	244				87
MIWI10-48D15		±15	±333	244				87

For each output

Input Specifications

Parameter	Model	Min.	Typ.	Max.	Unit
Input Surge Voltage (1 sec. max.)	24V Input Models	-0.7	---	50	VDC
	48V Input Models	-0.7	---	100	
Start-Up Threshold Voltage	24V Input Models	7	8	9	
	48V Input Models	14	16	18	
Under Voltage Shutdown	24V Input Models	---	---	8.5	
	48V Input Models	---	---	17	
Input Filter	All Models	Internal Pi Type			

Remote On/Off Control

Parameter	Conditions	Min.	Typ.	Max.	Unit
Converter On	3.5V ~ 12V or Open Circuit				
Converter Off	0~1.2V or Short Circuit (Pin 1 and Pin 2)				
Control Input Current (on)	Vctrl = 5V	---	---	500	μA
Control Input Current (off)	Vctrl = 0V	---	---	-500	μA
Control Common	Referenced to Negative Input				
Standby Input Current	Nominal Vin	---	---	10	mA

Output Specifications

Parameter	Conditions	Min.	Typ.	Max.	Unit
Output Voltage Setting Accuracy		---	±1.0	±2.0	%Vnom.
Output Voltage Balance	Dual Output, Balanced Loads	---	±1.0	±2.0	%
Line Regulation	Vin=Min. to Max. @Full Load	---	±0.5	±1.0	%
Load Regulation	I _o =0% to 100%	---	±0.5	±1.2	%
Minimum Load	No minimum Load Requirement				
Ripple & Noise	0-20 MHz Bandwidth	---	---	100	mV _{P-P}
Transient Recovery Time	25% Load Step Change	---	300	600	μsec
Transient Response Deviation		---	±3	±5	%
Temperature Coefficient		---	±0.01	±0.02	%/°C
Over Load Protection	Hiccup	---	150	---	%
Short Circuit Protection	Continuous, Automatic Recovery (Hiccup Mode 0.7Hz typ.)				

General Specifications						
Parameter	Conditions	Min.	Typ.	Max.	Unit	
I/O Isolation Voltage	60 Seconds	1500	---	---	VDC	
	1 Second	1800	---	---	VDC	
I/O Isolation Resistance	500 VDC	1000	---	---	MΩ	
I/O Isolation Capacitance	100kHz, 1V	---	1000	1500	pF	
Switching Frequency		300	330	360	kHz	
MTBF (calculated)	MIL-HDBK-217F@25°C, Ground Benign	1,000,000			Hours	
Safety Approvals	UL/cUL 60950-1 recognition(CSA certificate), IEC/EN 60950-1(CB-report)					
	UL/cUL 62368-1 recognition(UL certificate), IEC/EN 62368-1(CB-report)					

EMC Specifications				
Parameter	Standards & Level			Performance
EMI _(s)	Conduction	EN55022	Without external components	
	Radiation		With external components	
EMS _(s)	EN55024		Class A	
	ESD	EN61000-4-2 Air ± 8kV , Contact ± 6kV		A
	Radiated immunity	EN61000-4-3 10V/m		A
	Fast transient	EN61000-4-4 ±2kV		A
	Surge	EN61000-4-5 ±1kV		A
	Conducted immunity	EN61000-4-6 10Vrms		A

Environmental Specifications				
Parameter	Min.	Max.	Unit	
Operating Ambient Temperature Range (See Power Derating Curve)	-40	+85	°C	
Case Temperature	---	+105	°C	
Storage Temperature Range	-50	+125	°C	
Humidity (non condensing)	---	95	% rel. H	
Lead Temperature (1.5mm from case for 10Sec.)	---	260	°C	

Notes	
1	Specifications typical at Ta=+25°C, resistive load, nominal input voltage and rated output current unless otherwise noted.
2	Transient recovery time is measured to within 1% error band for a step change in output load of 75% to 100%.
3	We recommend to protect the converter by a fast blow fuse in the input supply line.
4	Other input and output voltages may be available, please contact MINMAX.
5	The external components might be required to meet EMI/EMS standard for some of test items. Please contact MINMAX for the solution in detail.
6	Specifications are subject to change without notice.

Characteristic Curves

All test conditions are at 25°C The figures are identical for MIWI10-24S033

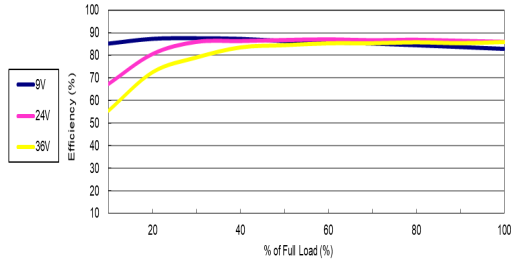

Efficiency Versus Output Current

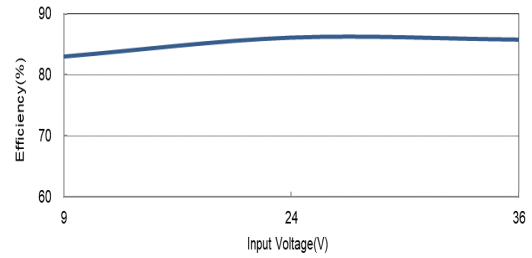

Efficiency Versus Input Voltage Full Load

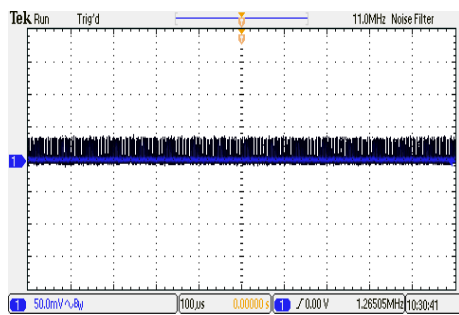

Typical Output Ripple and Noise
 $V_{in}=V_{in\ nom}$; Full Load

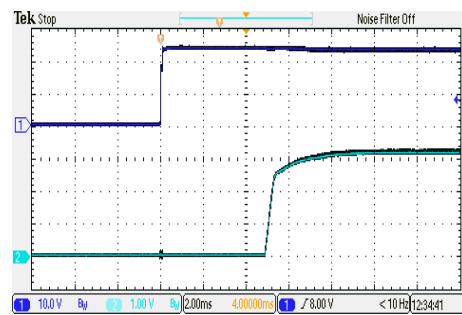

Typical Input Start-Up and Output Rise Characteristic
 $V_{in}=V_{in\ nom}$; Full Load

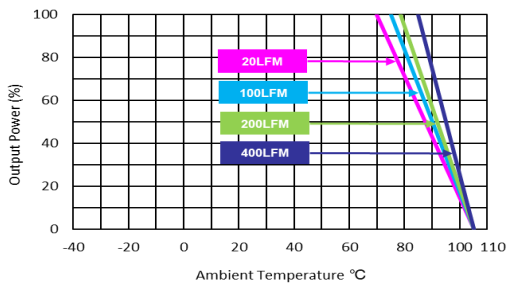

Derating Output Power Versus Ambient Temperature
 $V_{in}=V_{in\ nom}$

Characteristic Curves

All test conditions are at 25°C The figures are identical for MIWI10-24S05

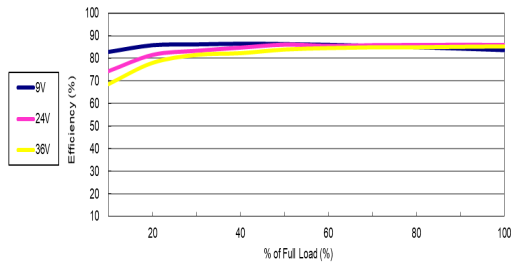

Efficiency Versus Output Current

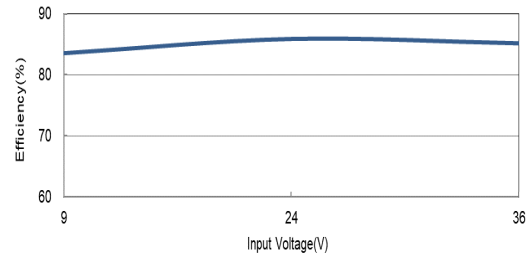

Efficiency Versus Input Voltage Full Load

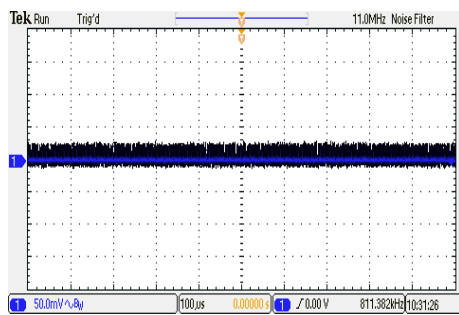

Typical Output Ripple and Noise
 $V_{in}=V_{in\ nom}$; Full Load

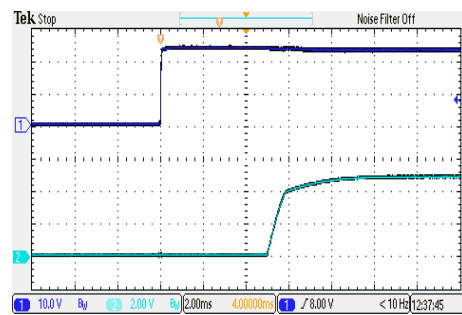

Typical Input Start-Up and Output Rise Characteristic
 $V_{in}=V_{in\ nom}$; Full Load

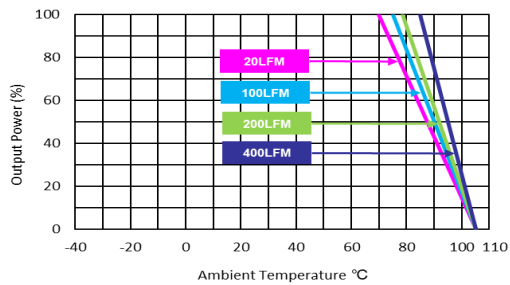

Derating Output Power Versus Ambient Temperature
 $V_{in}=V_{in\ nom}$

Characteristic Curves

All test conditions are at 25°C The figures are identical for MIWI10-24S051

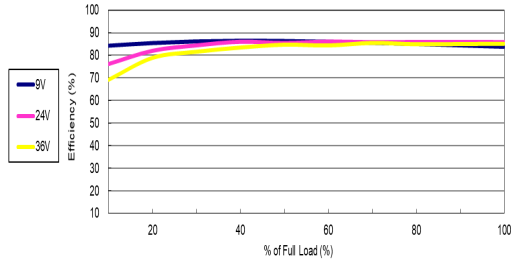

Efficiency Versus Output Current

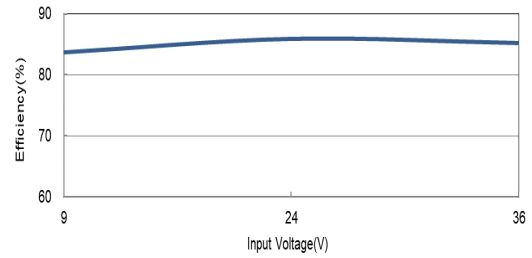

Efficiency Versus Input Voltage Full Load

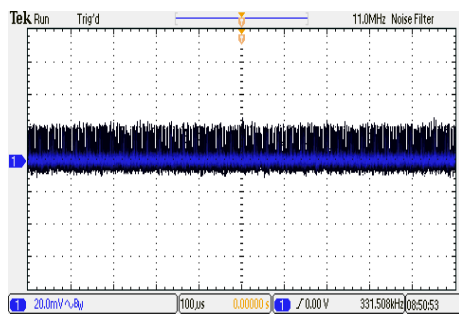

Typical Output Ripple and Noise
 $V_{in}=V_{in\ nom}$; Full Load

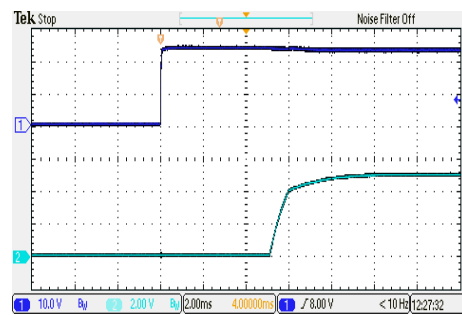

Typical Input Start-Up and Output Rise Characteristic
 $V_{in}=V_{in\ nom}$; Full Load

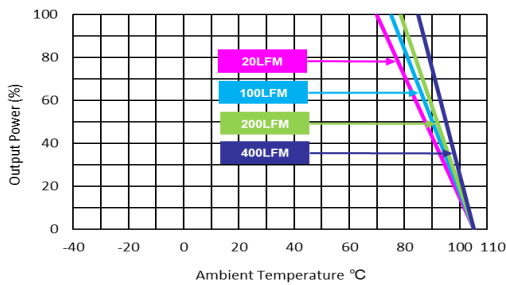

Derating Output Power Versus Ambient Temperature
 $V_{in}=V_{in\ nom}$

Characteristic Curves

All test conditions are at 25°C The figures are identical for MIWI10-24S12

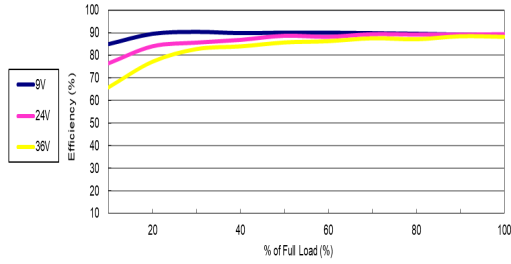

Efficiency Versus Output Current

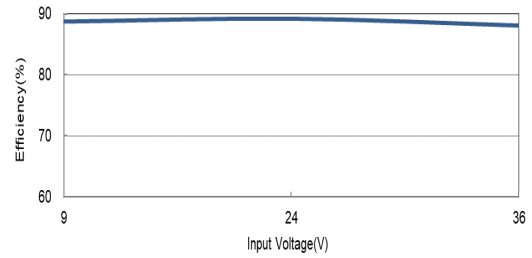

Efficiency Versus Input Voltage Full Load

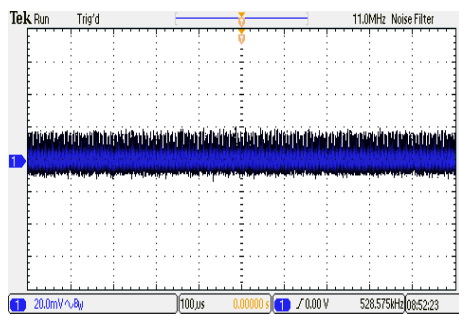

Typical Output Ripple and Noise
 $V_{in}=V_{in\ nom}$; Full Load

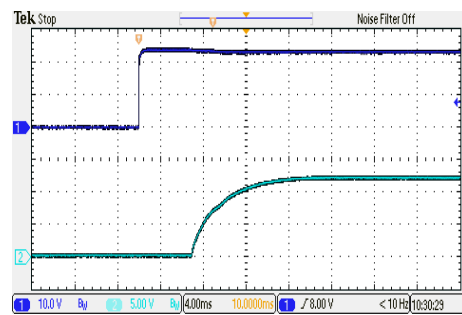

Typical Input Start-Up and Output Rise Characteristic
 $V_{in}=V_{in\ nom}$; Full Load

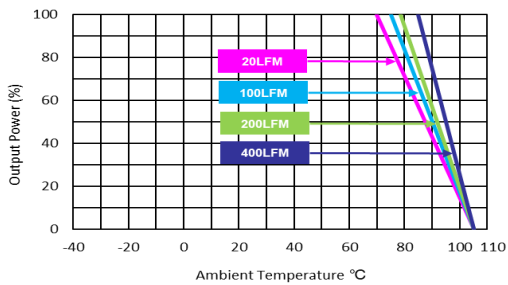

Derating Output Power Versus Ambient Temperature
 $V_{in}=V_{in\ nom}$

Characteristic Curves

All test conditions are at 25°C The figures are identical for MIWI10-24S15

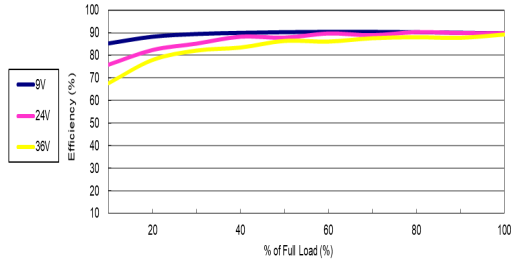

Efficiency Versus Output Current

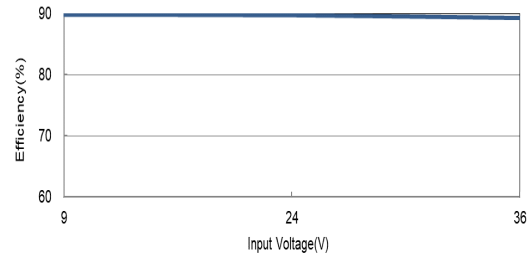

Efficiency Versus Input Voltage Full Load

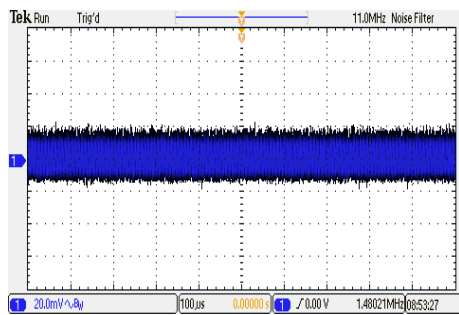

Typical Output Ripple and Noise
 $V_{in}=V_{in\ nom}$; Full Load

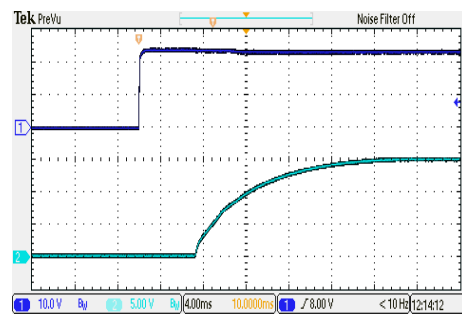

Typical Input Start-Up and Output Rise Characteristic
 $V_{in}=V_{in\ nom}$; Full Load

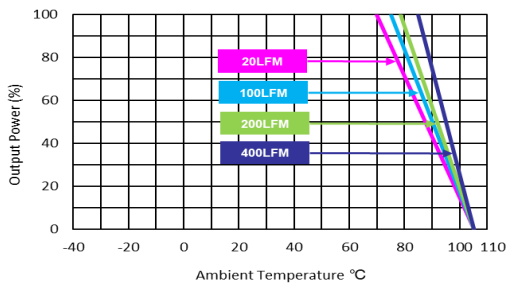

Derating Output Power Versus Ambient Temperature
 $V_{in}=V_{in\ nom}$

Characteristic Curves

All test conditions are at 25°C The figures are identical for MIWI10-24S24

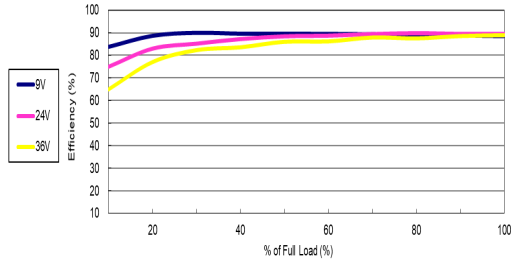

Efficiency Versus Output Current

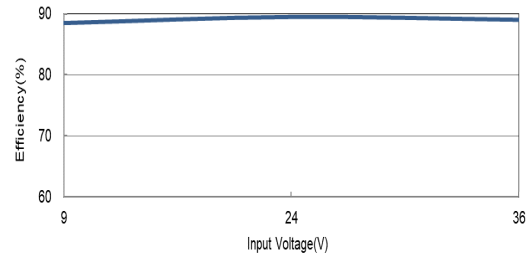

Efficiency Versus Input Voltage Full Load

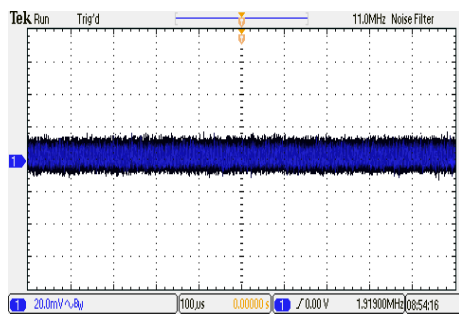

Typical Output Ripple and Noise
 $V_{in}=V_{in\ nom}$; Full Load

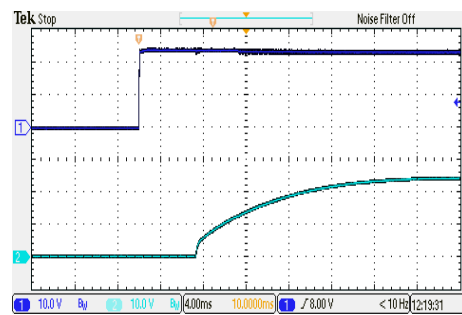

Typical Input Start-Up and Output Rise Characteristic
 $V_{in}=V_{in\ nom}$; Full Load

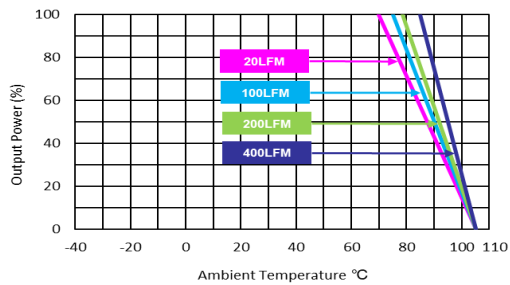

Derating Output Power Versus Ambient Temperature
 $V_{in}=V_{in\ nom}$

Characteristic Curves

All test conditions are at 25°C The figures are identical for MIWI10-24D12

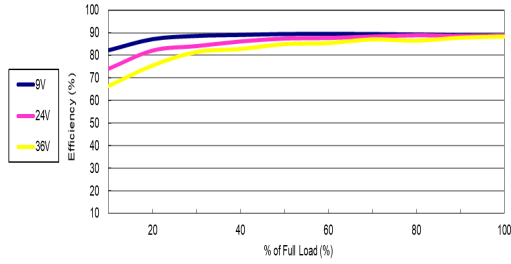

Efficiency Versus Output Current

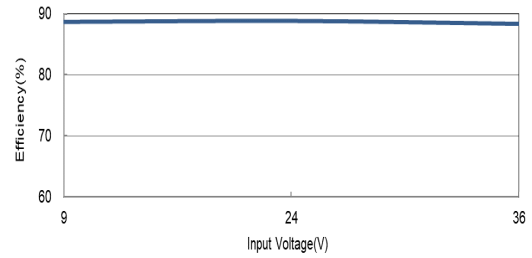

Efficiency Versus Input Voltage Full Load

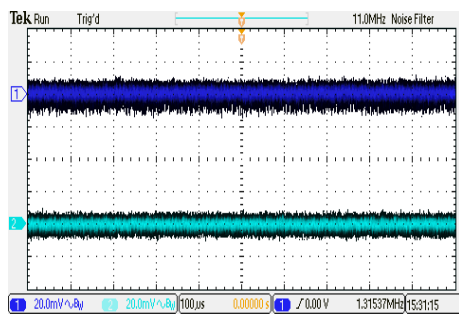

Typical Output Ripple and Noise
 $V_{in}=V_{in\ nom}$; Full Load

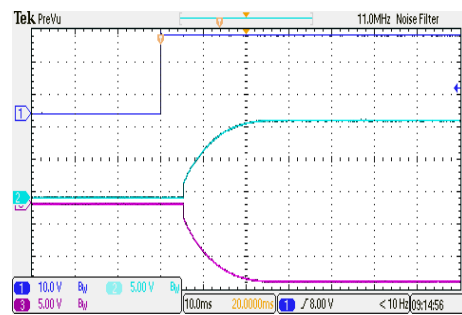

Typical Input Start-Up and Output Rise Characteristic
 $V_{in}=V_{in\ nom}$; Full Load

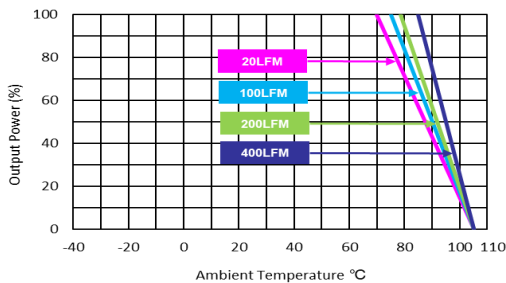

Derating Output Power Versus Ambient Temperature
 $V_{in}=V_{in\ nom}$

Characteristic Curves

All test conditions are at 25°C The figures are identical for MIW110-24D15

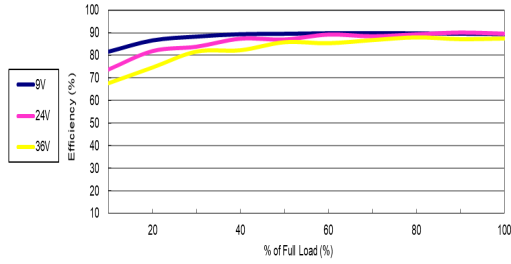

Efficiency Versus Output Current

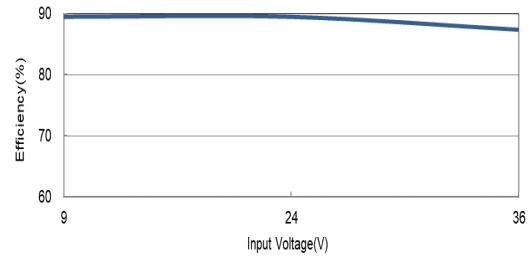

Efficiency Versus Input Voltage Full Load

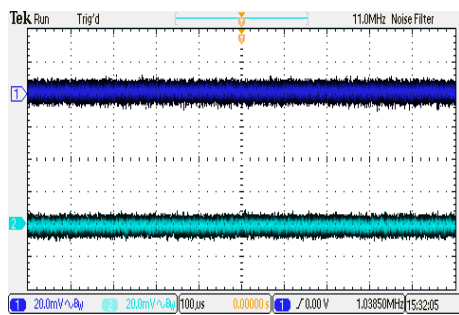

Typical Output Ripple and Noise
 $V_{in}=V_{in\ nom}$; Full Load

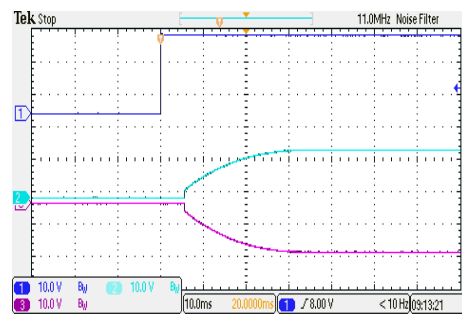

Typical Input Start-Up and Output Rise Characteristic
 $V_{in}=V_{in\ nom}$; Full Load

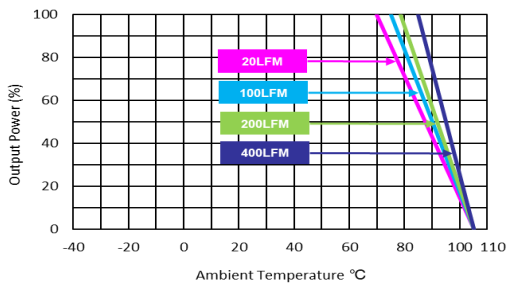

Derating Output Power Versus Ambient Temperature
 $V_{in}=V_{in\ nom}$

Characteristic Curves

All test conditions are at 25°C The figures are identical for MIWI10-48S033

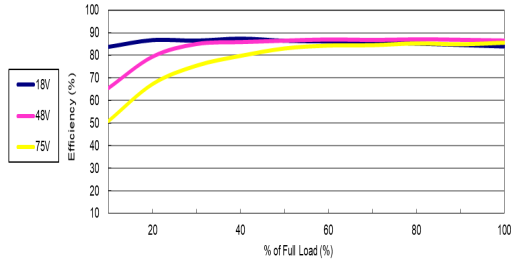

Efficiency Versus Output Current

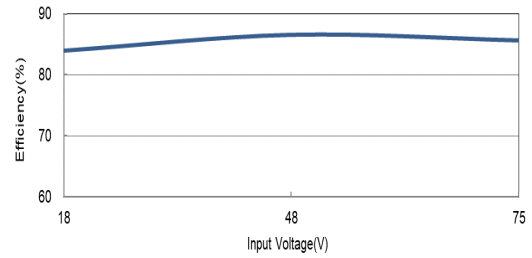

Efficiency Versus Input Voltage Full Load

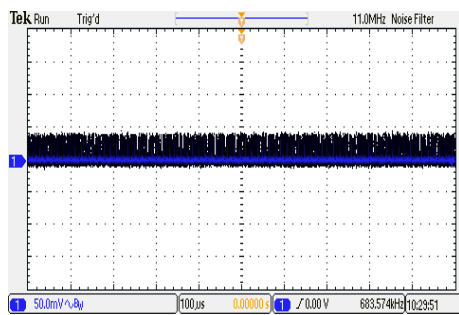

Typical Output Ripple and Noise
 $V_{in}=V_{in\ nom}$; Full Load

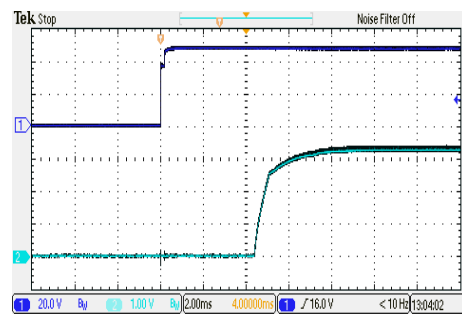

Typical Input Start-Up and Output Rise Characteristic
 $V_{in}=V_{in\ nom}$; Full Load

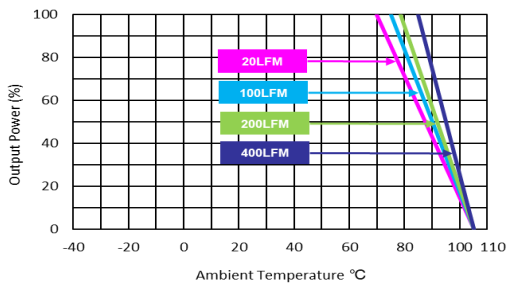

Derating Output Power Versus Ambient Temperature
 $V_{in}=V_{in\ nom}$

Characteristic Curves

All test conditions are at 25°C The figures are identical for MIWI10-48S05

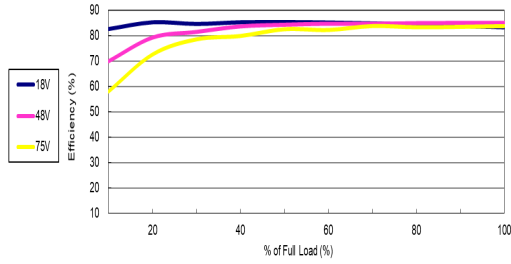

Efficiency Versus Output Current

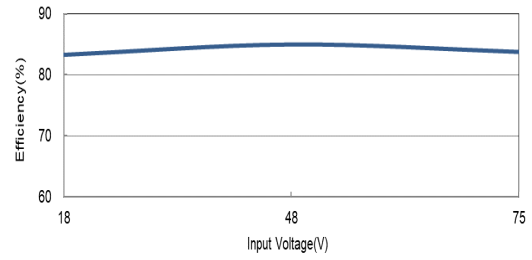

Efficiency Versus Input Voltage Full Load

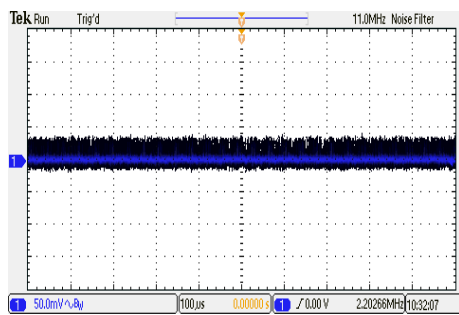

Typical Output Ripple and Noise
 $V_{in}=V_{in\ nom}$; Full Load

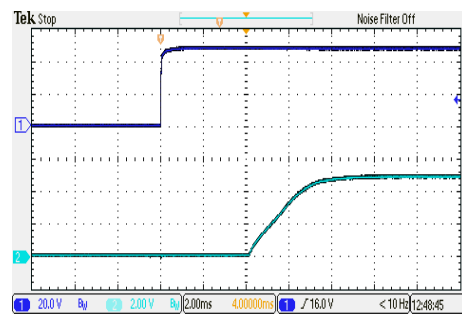

Typical Input Start-Up and Output Rise Characteristic
 $V_{in}=V_{in\ nom}$; Full Load

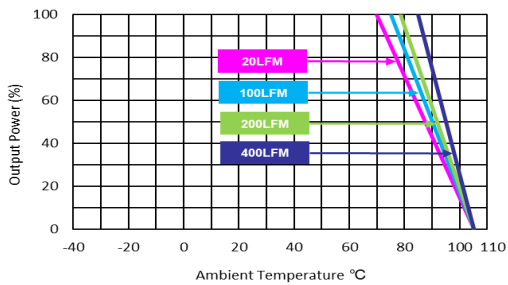

Derating Output Power Versus Ambient Temperature
 $V_{in}=V_{in\ nom}$

Characteristic Curves

All test conditions are at 25°C The figures are identical for MIWI10-48S051

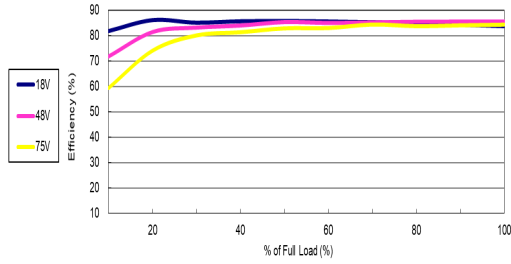

Efficiency Versus Output Current

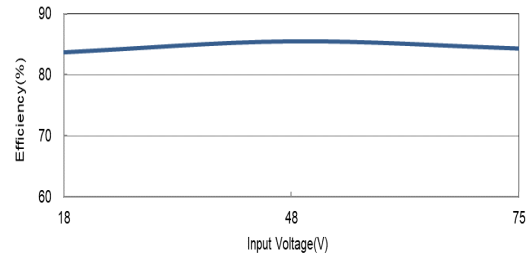

Efficiency Versus Input Voltage Full Load

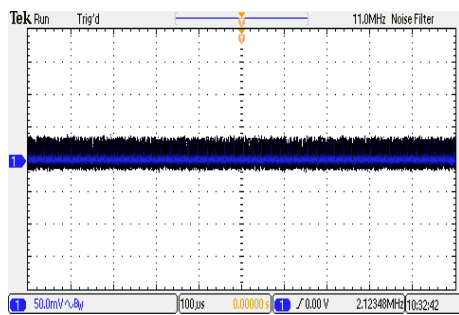

Typical Output Ripple and Noise
 $V_{in}=V_{in\ nom}$; Full Load

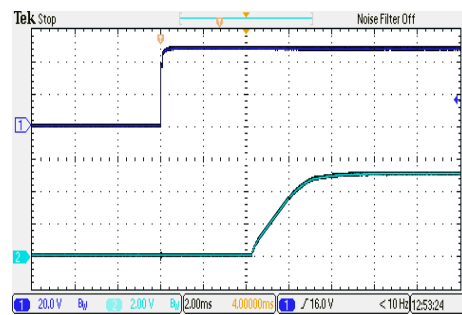

Typical Input Start-Up and Output Rise Characteristic
 $V_{in}=V_{in\ nom}$; Full Load

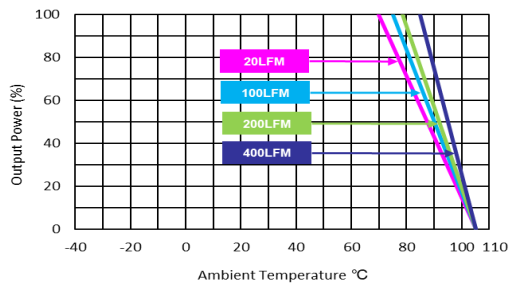

Derating Output Power Versus Ambient Temperature
 $V_{in}=V_{in\ nom}$

Characteristic Curves

All test conditions are at 25°C The figures are identical for MIW110-48S12

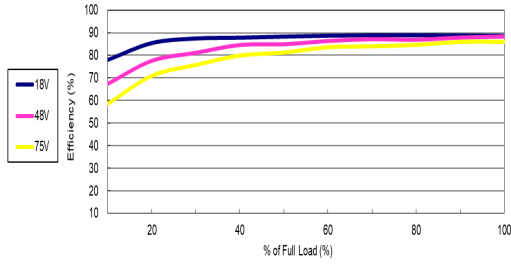

Efficiency Versus Output Current

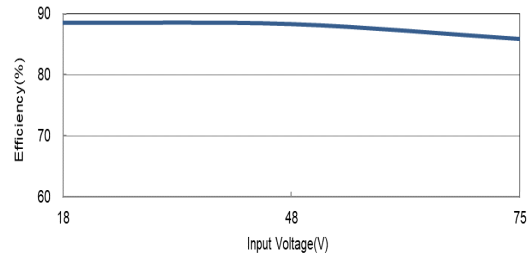

Efficiency Versus Input Voltage Full Load

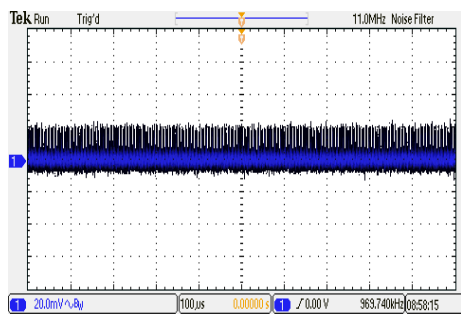

Typical Output Ripple and Noise
 $V_{in}=V_{in nom}$; Full Load

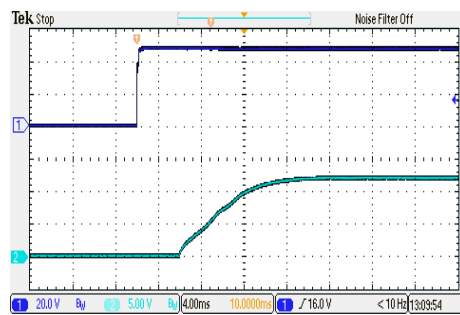

Typical Input Start-Up and Output Rise Characteristic
 $V_{in}=V_{in nom}$; Full Load

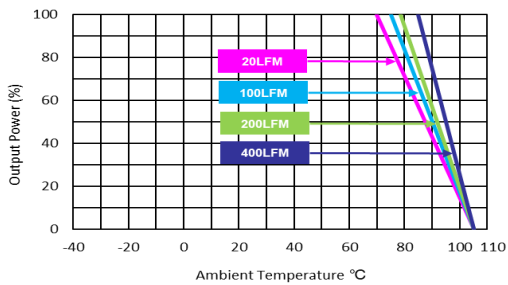

Derating Output Power Versus Ambient Temperature
 $V_{in}=V_{in nom}$

Characteristic Curves

All test conditions are at 25°C The figures are identical for MIWI10-48S15

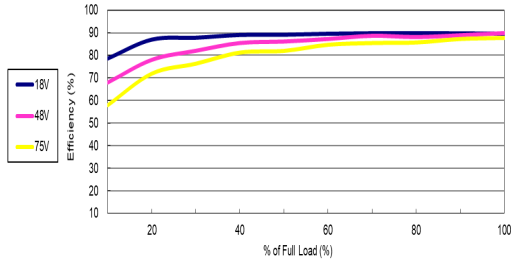

Efficiency Versus Output Current

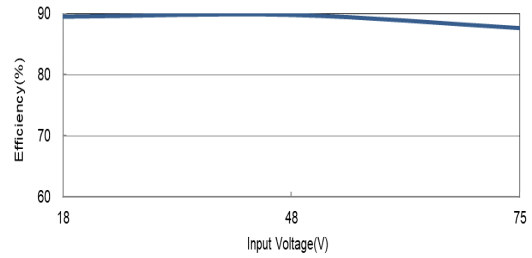

Efficiency Versus Input Voltage Full Load

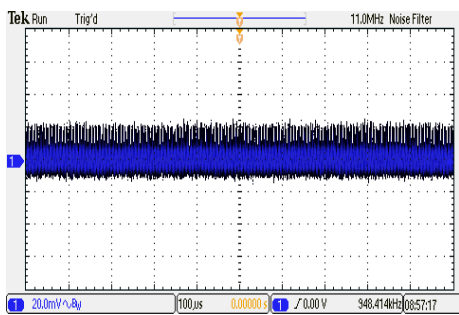

Typical Output Ripple and Noise
 $V_{in}=V_{in nom}$; Full Load

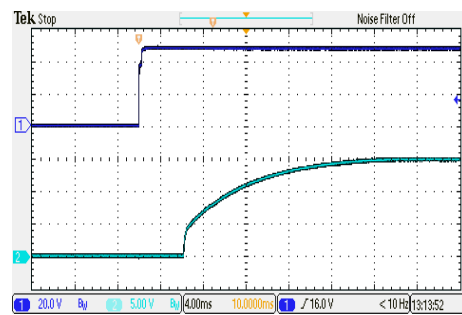

Typical Input Start-Up and Output Rise Characteristic
 $V_{in}=V_{in nom}$; Full Load

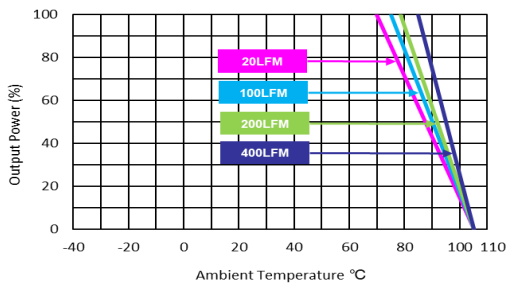

Derating Output Power Versus Ambient Temperature
 $V_{in}=V_{in nom}$

Characteristic Curves

All test conditions are at 25°C The figures are identical for MIWI10-48S24

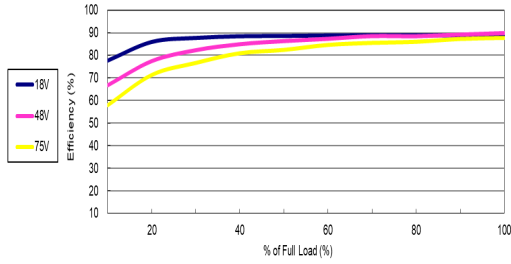

Efficiency Versus Output Current

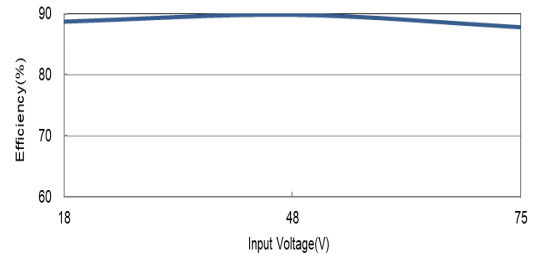

Efficiency Versus Input Voltage Full Load

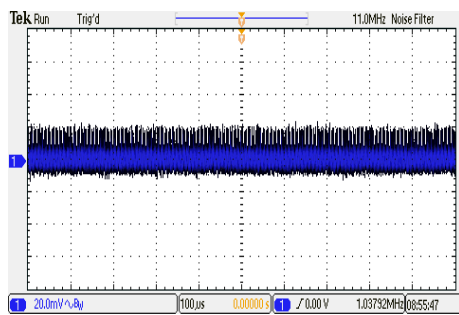

Typical Output Ripple and Noise
 $V_{in}=V_{in\ nom}$; Full Load

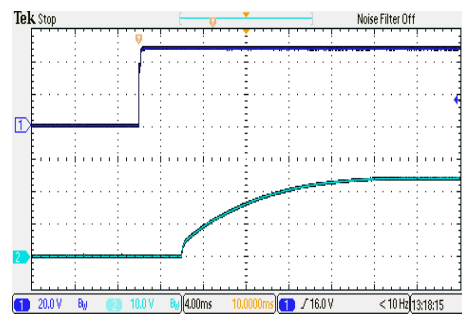

Typical Input Start-Up and Output Rise Characteristic
 $V_{in}=V_{in\ nom}$; Full Load

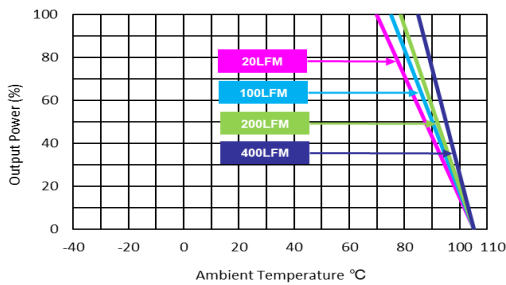

Derating Output Power Versus Ambient Temperature
 $V_{in}=V_{in\ nom}$

Characteristic Curves

All test conditions are at 25°C The figures are identical for MIWI10-48D12

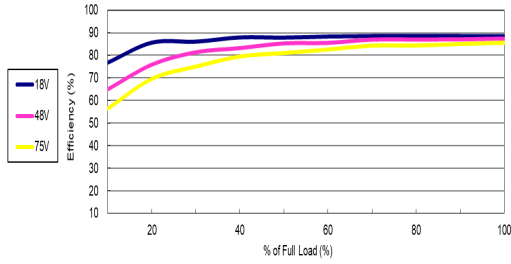

Efficiency Versus Output Current

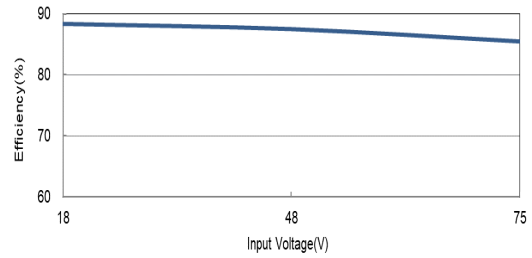

Efficiency Versus Input Voltage Full Load

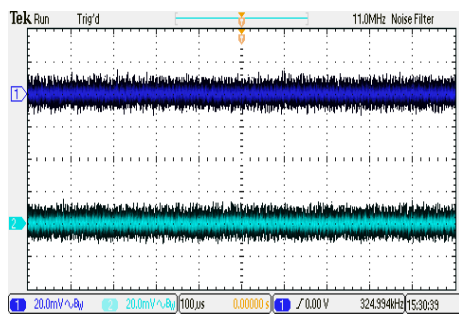

Typical Output Ripple and Noise
 $V_{in}=V_{in\ nom}$; Full Load

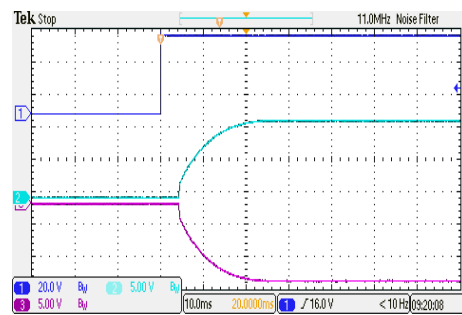

Typical Input Start-Up and Output Rise Characteristic
 $V_{in}=V_{in\ nom}$; Full Load

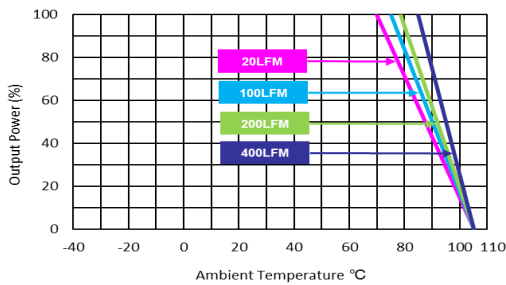

Derating Output Power Versus Ambient Temperature
 $V_{in}=V_{in\ nom}$

Characteristic Curves

All test conditions are at 25°C The figures are identical for MIW110-48D15

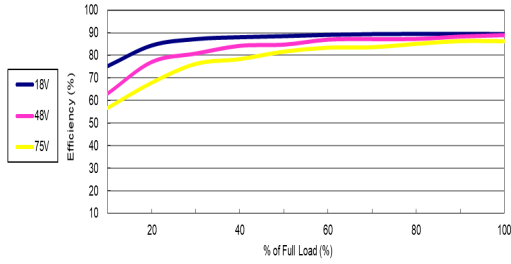

Efficiency Versus Output Current

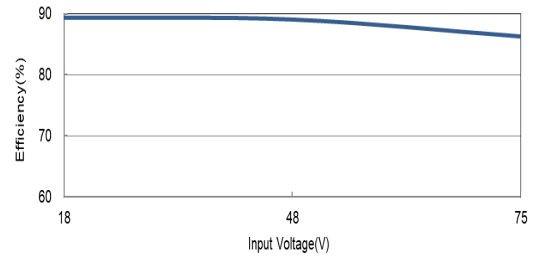

Efficiency Versus Input Voltage Full Load

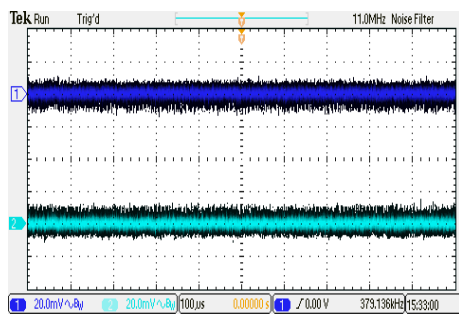

Typical Output Ripple and Noise
 $V_{in}=V_{in\ nom}$; Full Load

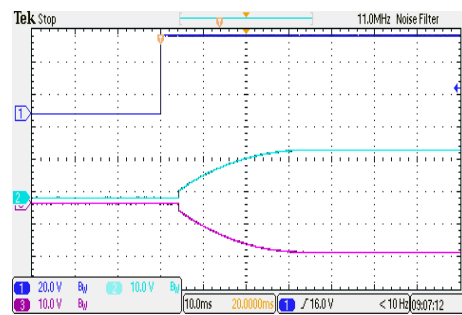

Typical Input Start-Up and Output Rise Characteristic
 $V_{in}=V_{in\ nom}$; Full Load

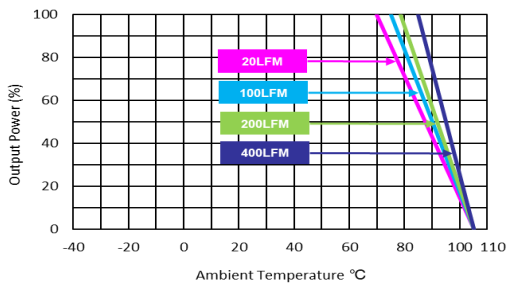

Derating Output Power Versus Ambient Temperature
 $V_{in}=V_{in\ nom}$

Package Specifications

Mechanical Dimensions

Pin Connections

Pin	Single Output	Dual Output	Diameter mm (inches)
1	Remote On/Off	Remote On/Off	∅ 0.5 [0.02]
2	-Vin	-Vin	∅ 0.5 [0.02]
3	-Vin	-Vin	∅ 0.5 [0.02]
9	No Pin	Common	∅ 0.5 [0.02]
11	NC	-Vout	∅ 0.5 [0.02]
14	+Vout	+Vout	∅ 0.5 [0.02]
16	-Vout	Common	∅ 0.5 [0.02]
22	+Vin	+Vin	∅ 0.5 [0.02]
23	+Vin	+Vin	∅ 0.5 [0.02]

NC: No Connection

- ▶ All dimensions in mm (inches)
- ▶ Tolerance: X.X±0.5 (X.XX±0.02)
X.XX±0.25 (X.XXX±0.01)
- ▶ Pin diameter tolerance: X.X±0.05 (X.XX±0.002)

Physical Characteristics

Case Size	: 31.8x20.3x10.2mm (1.25x0.80x0.40 inches)
Case Material	: Metal with Non-Conductive Baseplate
Pin Material	: Copper Alloy
Weight	: 17.3g

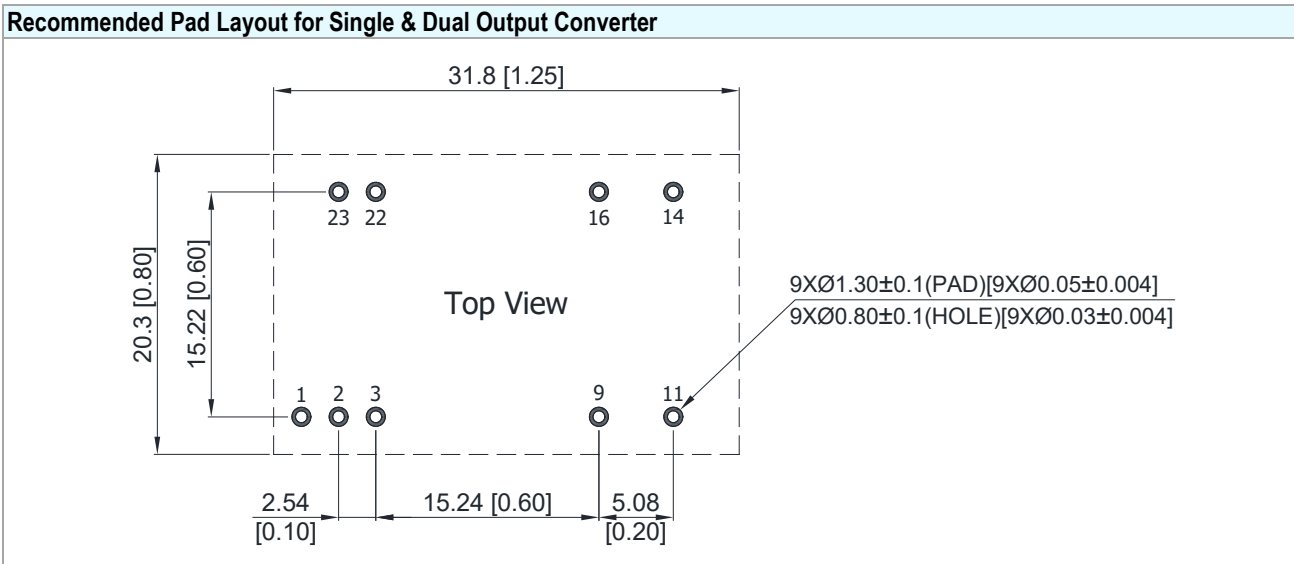

Test Setup

Input Reflected-Ripple Current Test Setup

Input reflected-ripple current is measured with an inductor L_{in} (4.7 μ H) and C_{in} (220 μ F, ESR < 1.0 Ω at 100 kHz) to simulate source impedance. Capacitor C_{in} offsets possible battery impedance. Current ripple is measured at the input terminals of the module, measurement bandwidth is 0-500 kHz.

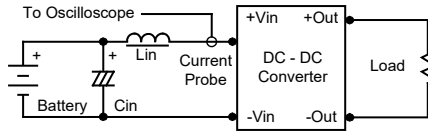

Peak-to-Peak Output Noise Measurement Test

Use a C_{out} 0.47 μ F ceramic capacitor. Scope measurement should be made by using a BNC socket, measurement bandwidth is 0-20 MHz. Position the load between 50 mm and 75 mm from the DC-DC Converter.

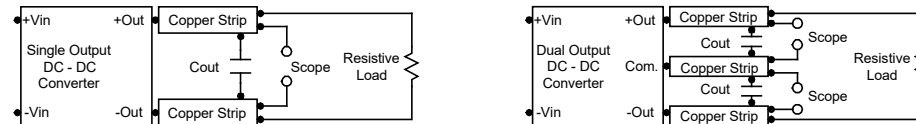

Technical Notes

Remote On/Off

Positive logic remote on/off turns the module on during a logic high voltage on the remote on/off pin, and off during a logic low. To turn the power module on and off, the user must supply a switch to control the voltage between the on/off terminal and the -Vin terminal. The switch can be an open collector or equivalent. A logic low is 0V to 1.2V. A logic high is 3.5V to 12V. The maximum sink current at the on/off terminal (Pin 1) during a logic low is -100 μ A.

Overload Protection

To provide protection in a fault (output overload) condition, the unit is equipped with internal current limiting circuitry and can endure current limiting for an unlimited duration. At the point of current-limit inception, the unit shifts from voltage control to current control. The unit operates normally once the output current is brought back into its specified range.

Overvoltage Protection

The output overvoltage clamp consists of control circuitry, which is independent of the primary regulation loop, that monitors the voltage on the output terminals. The control loop of the clamp has a higher voltage set point than the primary loop. This provides a redundant voltage control that reduces the risk of output overvoltage.

Input Source Impedance

The power module should be connected to a low ac-impedance input source. Highly inductive source impedances can affect the stability of the power module. In applications where power is supplied over long lines and output loading is high, it may be necessary to use a capacitor at the input to ensure startup. By using a good quality low Equivalent Series Resistance (ESR < 1.0 Ω at 100 kHz) capacitor of a 4.7 μ F for the 24V input devices and a 2.2 μ F for the 48V devices, capacitor mounted close to the power module helps ensure stability of the unit.

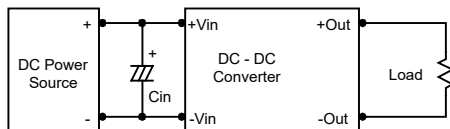

Output Ripple Reduction

A good quality low ESR capacitor placed as close as practicable across the load will give the best ripple and noise performance. To reduce output ripple, it is recommended to use 3.3 μ F capacitors at the output.

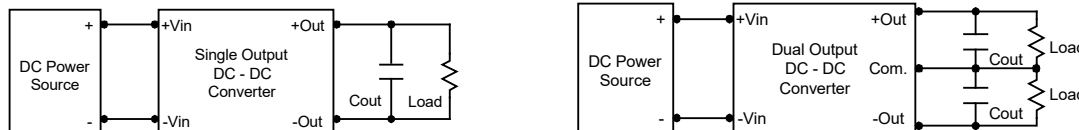

Maximum Capacitive Load

The MIW10 series has limitation of maximum connected capacitance on the output. The power module may operate in current limiting mode during start-up, affecting the ramp-up and the startup time. The maximum capacitance can be found in the data sheet.

Thermal Considerations

Many conditions affect the thermal performance of the power module, such as orientation, airflow over the module and board spacing. To avoid exceeding the maximum temperature rating of the components inside the power module, the case temperature must be kept below 105 $^{\circ}$ C. The derating curves are determined from measurements obtained in a test setup.

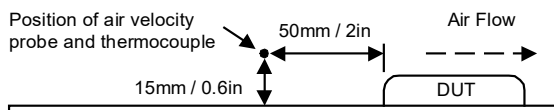

Remote On/Off Implementation

The positive logic remote ON/OFF control circuit is included. Turns the module ON during logic High on the ON/Off pin and turns OFF during logic Low. The ON/OFF input signal ($V_{on/off}$) that referenced to GND. If not using the remote on/off feature, please open circuit between on/off pin and -Vin pin to turn the module on.

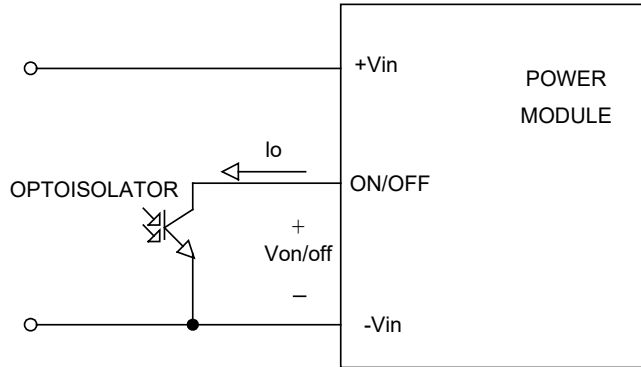

Isolated-Closure Remote ON/OFF

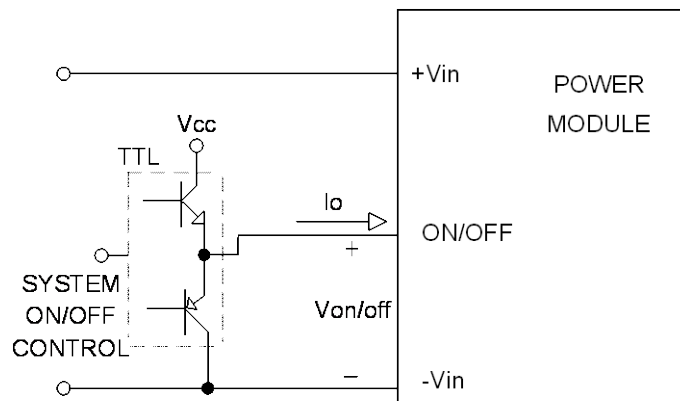

Level Control Using TTL Output

Packaging Information

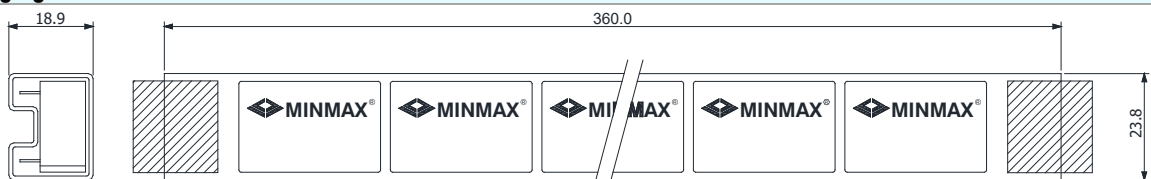

Unit: mm
10 PCS per TUBE

Wave Soldering Considerations

Lead free wave solder profile

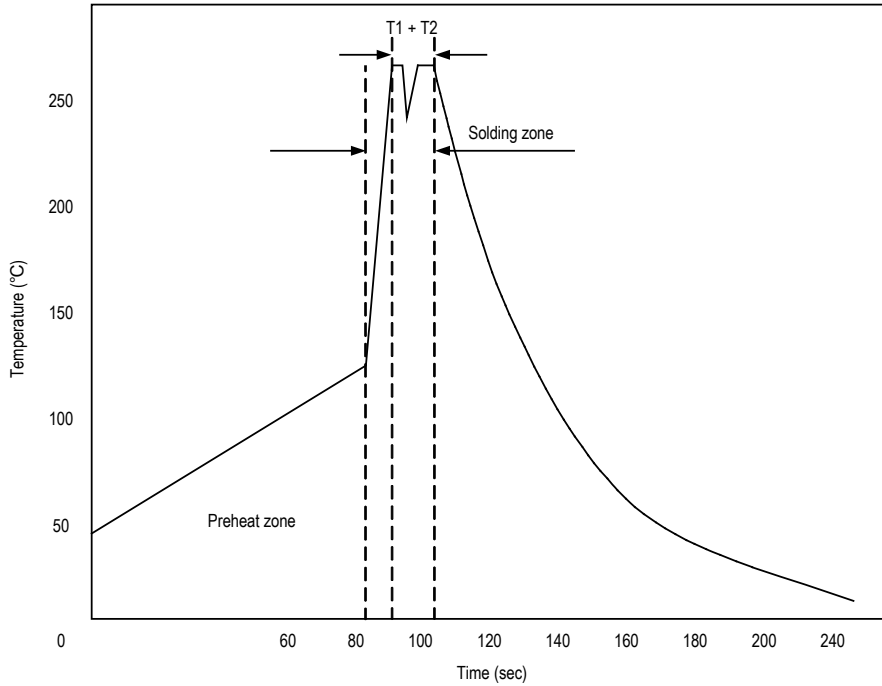

Zone	Reference Parameter
Preheat	Rise temp. speed : 3°C/sec max.
zone	Preheat temp. : 100~130°C
Actual	Peak temp. : 250~260°C
heating	Peak time(T1+T2) : 4~6 sec

Hand Welding Parameter

Reference Solder: Sn-Ag-Cu : Sn-Cu : Sn-Ag

Hand Welding: Soldering iron : Power 60W

Welding Time: 2~4 sec

Temp.: 380~400°C

Part Number Structure

M	I	WI	10	-	24	S	033
Package Type DIP-24	Ultra-wide 4:1 Input Voltage Range	Output Power 10 Watt	Input Voltage Range 24: 9 ~ 36 VDC 48: 18 ~ 75 VDC		Output Quantity S: Single D: Dual	Output Voltage 033: 3.3 VDC 05: 5 VDC 051: 5.1 VDC 12: 12 VDC 15: 15 VDC 24: 24 VDC	

MTBF and Reliability

The MTBF of MIWI10 series of DC-DC converters has been calculated using

MIL-HDBK 217F NOTICE2, Operating Temperature 25°C, Ground Benign.

Model	MTBF	Unit
MIWI10-24S033	1,223,342	Hours
MIWI10-24S05	1,106,335	
MIWI10-24S051	1,071,030	
MIWI10-24S12	1,268,708	
MIWI10-24S15	1,372,600	
MIWI10-24S24	1,370,350	
MIWI10-24D12	1,309,203	
MIWI10-24D15	1,396,461	
MIWI10-48S033	1,256,357	
MIWI10-48S05	1,132,075	
MIWI10-48S051	1,173,055	
MIWI10-48S12	1,338,065	
MIWI10-48S15	1,404,220	
MIWI10-48S24	1,401,865	
MIWI10-48D12	1,182,227	
MIWI10-48D15	1,331,528	